



# AquaCal® Operation Manual

## HEATWAVE SUPERQUIET®



*Firmware Version 1.xxx*

### Important

Read this document before operating / installing this product

For additional product manuals and operation / installation procedures, please visit [www.AquaCal.com](http://www.AquaCal.com)

  
MODEL / SERIAL NUMBER



# Table of Contents

---

<b>Contacting AquaCal AutoPilot, Inc.</b> .....	<b>1</b>
<b>Safety Instructions</b> .....	<b>1</b>
<b>1 - Operation</b> .....	<b>3</b>
1.1 Display Door .....	3
1.2 Wake Up Heat Pump .....	3
1.3 Display Panel .....	4
1.4 Activate Heat Mode, Cool Mode, Auto Mode, or Deactivate Equipment .....	6
1.5 Set Temperature .....	7
1.6 Set Up Programming .....	7
1.6.a Setting Date and Time .....	7
1.6.b Using Entry Code to Access Heat Pump .....	9
1.6.c Setting Entry Code Option .....	9
1.6.d Disabling Entry Code Option .....	11
1.6.e Configure Variable Speed Compressors .....	12
1.7 External Equipment .....	17
1.7.a Operating Heat Pump with a Call Flex .....	17
1.7.b Operating Heat Pump (With an External Controller) .....	20
1.7.c Operating Heat Pump (With an External Flow Switch) .....	20
1.7.d Operating Heat Pump (With a Gas Back-Up) .....	20
d.1 Using Gas Boost .....	21
1.7.e Operating Multiple Connected Heat Pumps .....	22
<b>2 - Maintenance</b> .....	<b>23</b>
2.1 Water Chemistry .....	23
2.2 Cleaning Equipment .....	24
2.3 Clearances .....	25
2.4 Irrigation and Storm Run-Off .....	26
2.5 Water Flow Rates .....	26
2.6 Adjusting Water Flow Using $\Delta T$ (Delta-T) .....	27
2.7 Planned Maintenance .....	30
2.8 Winterizing .....	31
<b>3 - Troubleshooting</b> .....	<b>34</b>
3.1 Fault Codes .....	35
3.2 Issues and Resolutions .....	41
<b>4 - Appendix</b> .....	<b>49</b>
4.1 Factory Defaults .....	49
4.2 Identifying Model Specifications .....	50
4.3 Weights .....	52
4.4 Heating Recommendations .....	53
4.5 Cooling Recommendations .....	53
4.6 Available Accessories .....	53

## Contacting AquaCal AutoPilot, Inc.

For further assistance, please contact the distributor or installer of this product.

If unavailable, please contact AquaCal® for a partner in your area. To better assist you, please have the heat pump model and serial number available.

- See "Identifying Model Specifications" on page 50.

Product Information:	
Website	www.AquaCal.com
Phone	(1) 727-823-5642
Hours	8-5 pm, Eastern M-F

Service Information:	
Website	www.AquaCal.com/request-heat-pump-service/

## SAFETY INSTRUCTIONS

- For personal safety, and to avoid damage to equipment, follow all safety instructions displayed on the equipment and within this manual. Repair and service of heat pump must be performed by an authorized service center.
- Warranties may be voided if the equipment has been improperly installed, maintained or serviced.
- If service is deemed necessary, please contact AquaCal. See "Contacting AquaCal AutoPilot, Inc." above.

### SAFETY SIGNALS

Throughout this document, safety signals have been placed where particular attention is required.



**DANGER**

Failure to heed the following will result in injury or death.



**WARNING**

Failure to heed the following may result in injury or death.



**NOTICE**

Failure to heed the following may result in damage to equipment.

When installing and using your heat pump basic safety precautions must always be followed, including the following:



**DANGER**

Failure to heed the following will result in injury or death.

- The heat pump utilizes high voltage and rotating equipment. Use caution when servicing.
- RISK OF ELECTRICAL SHOCK FROM ENERGY STORED IN CAPACITORS - MODELS EQUIPPED WITH VARIABLE FREQUENCY COMPRESSOR DRIVES STORE ELECTRICITY EVEN AFTER THE POWER HAS BEEN DEACTIVATED AT THE POWER BREAKER. ***Wait for 2 minutes after the shut down of equipment before servicing.***
- Follow all National Electric Codes (NEC) and/or State and Local guidelines.



**! WARNING**

Failure to heed the following may result in injury or death.

- Installation and repairs must be performed by a qualified technician.
- The heat pump contains refrigerant under pressure. Repairs to the refrigerant circuit must not be attempted by untrained and/or unqualified individuals. Service must be performed only by qualified HVAC technicians. Recover refrigerant before opening the system.
- Improper water chemistry can present a serious health hazard. To avoid possible hazards, maintain pool/spa water per standards as detailed in this document.
- Prolonged immersion in water warmer than normal body temperature may cause a condition known as Hyperthermia. The symptoms of Hyperthermia include unawareness of impending hazard, failure to perceive heat, failure to recognize the need to exit the pool or spa, and unconsciousness. The use of alcohol, drugs, or medication can greatly increase the risk of fatal Hyperthermia. People having an adverse medical history, or pregnant women should consult a physician before using a hot tub or spa. Children and the elderly should be supervised by a responsible adult.
- Prolonged immersion in water colder than normal body temperature may cause a condition known as Hypothermia. The symptoms of Hypothermia include shivering (although as hypothermia worsens, shivering stops), clumsiness or lack of coordination, slurred speech or mumbling, confusion and poor decision-making, drowsiness or low energy, lack of concern about personal welfare, progressive loss of consciousness, weak pulse and slow or shallow breathing. Persons having an adverse medical history, or pregnant women, should consult a physician before immersing in a cold body of water. Children and the elderly should be supervised by a responsible adult.
- This appliance is not to be used by persons (including children) with reduced physical, sensory, or mental capabilities, or lack of experience and knowledge, unless they have been given supervision or instruction.
- Children must be supervised and are not to play with the appliance.

**NOTICE**

Failure to heed the following may result in damage to equipment.

- Maintain proper water chemistry to avoid damage to the pump, filter, pool shell, etc.
- Water flow exceeding the maximum flow rate requires a bypass. Damage due to excessive water flow will void the warranty.

**SAVE THESE INSTRUCTIONS**

# 1 - Operation

## IN THIS SECTION:

1.1 Display Door	3
1.2 Wake Up Heat Pump	3
1.3 Display Panel	4
1.4 Activate Heat Mode, Cool Mode, Auto Mode, or Deactivate Equipment	6
1.5 Set Temperature	7
1.6 Set Up Programming	7
1.6.a Setting Date and Time	7
1.6.b Using Entry Code to Access Heat Pump	9
1.6.c Setting Entry Code Option	9
1.6.d Disabling Entry Code Option	11
1.6.e Configure Variable Speed Compressors	12
1.7 External Equipment	17
1.7.a Operating Heat Pump with a Call Flex	17
1.7.b Operating Heat Pump (With an External Controller)	20
1.7.c Operating Heat Pump (With an External Flow Switch)	20
1.7.d Operating Heat Pump (With a Gas Back-Up)	20
1.7.e Operating Multiple Connected Heat Pumps	22

## 1.1 Display Door

The display panel is located in a door compartment on the front of the heat pump. This compartment is designed to protect the display against harsh weather. It can also be padlocked for extra security.

- Press the **bottom** of the panel to open the display panel door.
- To close, push the display panel up. Then press the **bottom** of the panel in until a clicking noise is heard.

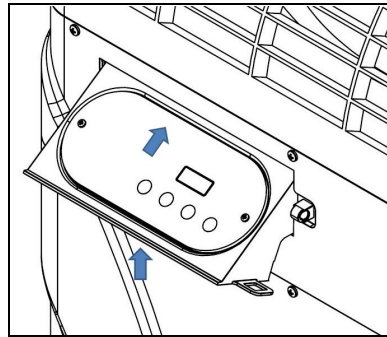
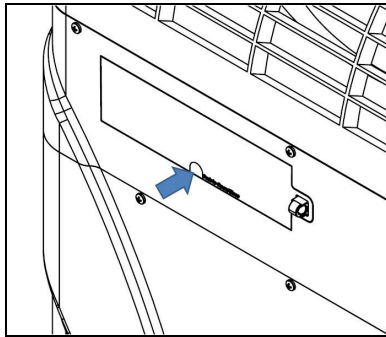

## 1.2 Wake Up Heat Pump

The display's backlight will be off when the heat pump is in sleep mode. To wake up the heat pump, slowly slide a finger across the buttons.

- The display will illuminate.
- The message "KEYPAD UNLOCKED" will briefly appear.
- Then the water temperature and mode will display.

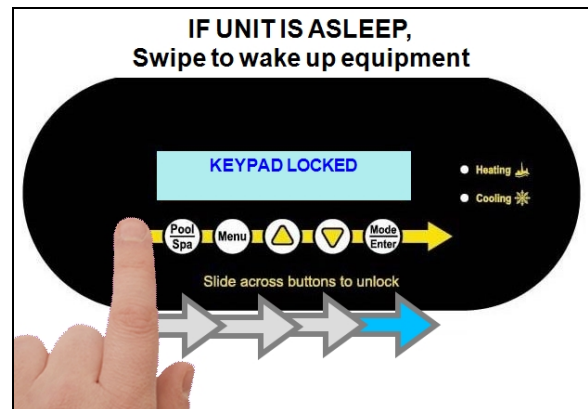





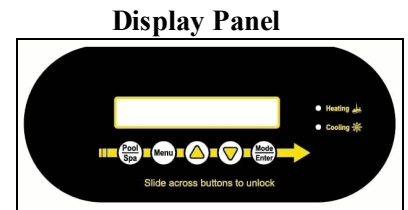

## 1.3 Display Panel

The following information outlines the operation for a standard installation.

- Control Buttons will operate differently for custom installations; such as when a heat pump is connected to an external controller or multiple heat pump configuration.
  - See "*Operating Heat Pump (With an External Controller)*" on page 20.
  - See "*Operating Multiple Connected Heat Pumps*" on page 22.



## Buttons

Buttons	Description
	Slowly slide a finger across the buttons from left to right to disable the sleep mode. Sleep mode will automatically reactivate after three minutes have passed.
	Select either the pool or the spa thermostat.
	Enter the user menu for heat pump options.
	Used to increase temperature set point and navigate through menu options.
	Used to decrease temperature set point and navigate through menu options.
	Used to select the heat pump's operating mode. Also used to edit or confirm options in a menu.

## Indicator Lights

Indicators	Description
Heating	Red LED indicates the unit is heating the water.
Cooling	Blue LED indicates the unit is cooling the water.
When calling for heating or cooling, up to a three-minute delay may occur before the compressor starts. The compressor must be operating before the indicator will illuminate.	

## Display

	Display	Description
Entry code required	ENTRY CODE 00	The heat pump has a user lock enabled. See " <i>Using Entry Code to Access Heat Pump</i> " on page 9.
No water flow	NO WATER FLOW HEAT SETPOINT 75°F	No water flow is detected. The filter pump is off or the heat pump is not receiving the correct water flow.
Primary Heat Pump	POOL TEMP 71°F PRIMARY UNIT	Primary heat pump controlling other connected heat pumps
Remote Controlled - by primaryHeat Pump	WATER TEMP 71°F SECONDARY UNIT 01	Heat Pump is set to be controlled by another connected heat pump.
Remote Controlled - by external controller	WATER TEMP 75°F UNDER REMOTE CONTROL	Heat Pump is set to be controlled by an external controller.
Set to 75° F - Maintaining	POOL TEMP 70°F AUTO SETPOINT 75°F	Maintaining a water temperature set on the thermostat. In this example, the pool thermostat has been set to 75° F.
Set to 45° F - Cooling	POOL TEMP 70°F COOL SETPOINT 45°F	Cooling water to point set on the thermostat. In this example, the pool thermostat has been set to 45° F.
Set to 75° F - Heating	POOL TEMP 70°F HEAT SETPOINT 75°F	Heating water to point set on the thermostat. In this example, the pool thermostat has been set to 75° F.
Set to Off	POOL TEMP 70°F HEAT PUMP OFF	The heat pump has been deactivated using the "Mode / Enter" button.

## 1.4 Activate Heat Mode, Cool Mode, Auto Mode, or Deactivate Equipment

Press "Mode / Enter" button until the desired mode is displayed.

- HEATING MODE- After the fan and compressor start, the red "Heating" light will activate.
- COOLING MODE - After the fan and compressor start, the blue "Cooling" light will activate.
- AUTO MODE - After the fan and compressor start, the heat pump will maintain the set temperature within 1°. The red "Heating" or blue "Cooling" light will activate.
- OFF - The heat pump will indicate it is deactivated. The current water temperature will be displayed.

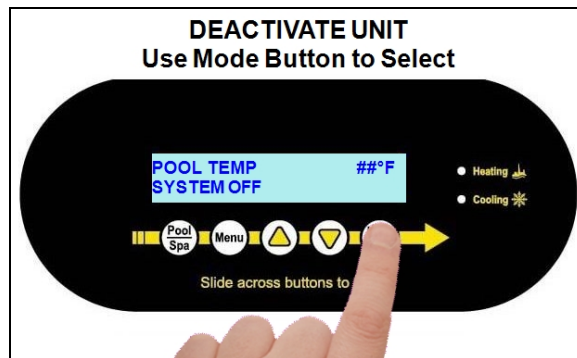
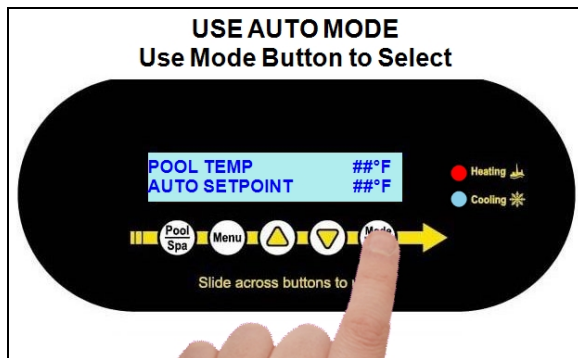
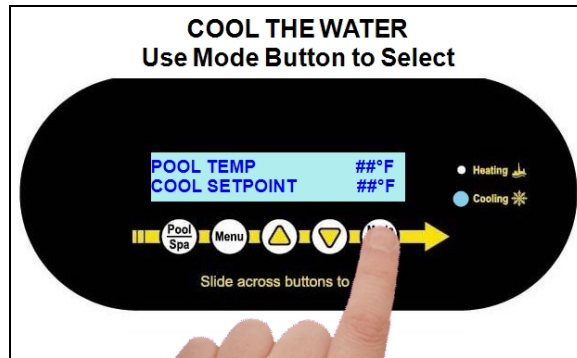
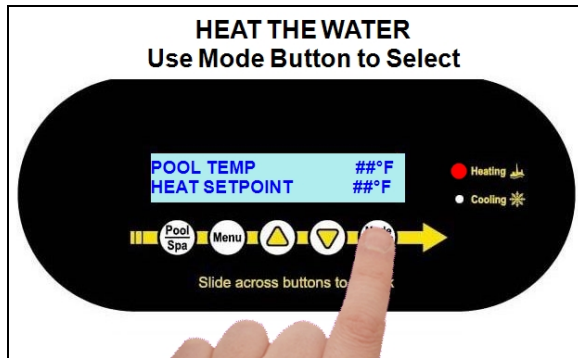

## 1.5 Set Temperature

Select the pool or spa thermostat. Then press the up or down arrow to set the desired temperature (setpoint) for the water.

### PLEASE NOTE:

*The heat pump will not operate if incoming water temperatures are above 110° F (43° C). If sustained water temperatures will fall below 32° F (0° C), the equipment must be winterized in order to prevent damage. See "Winterizing"*

- The heating indicator will illuminate when heating the water.
- The cooling indicator will illuminate when cooling the water.

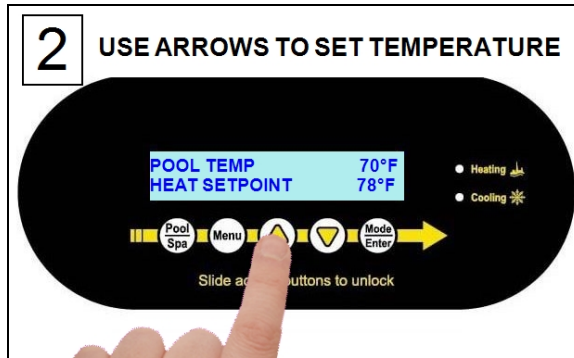
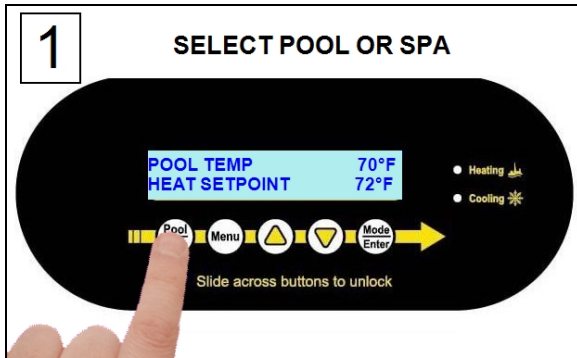

## 1.6 Set Up Programming

### 1.6.a Setting Date and Time

Set the heat pump's time and date using the following steps.

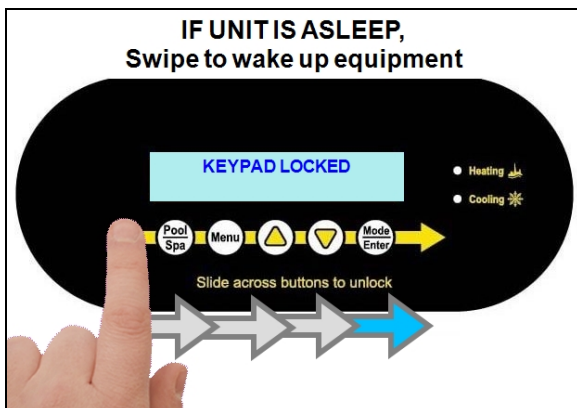

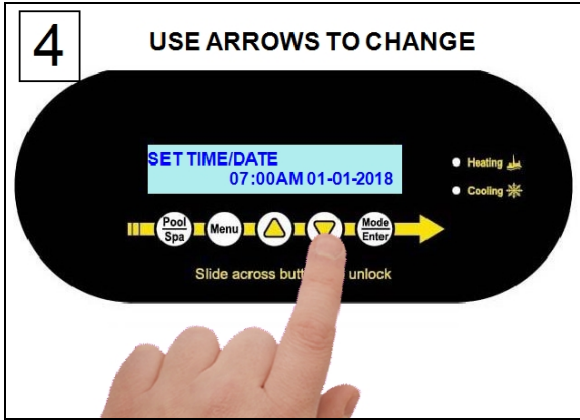
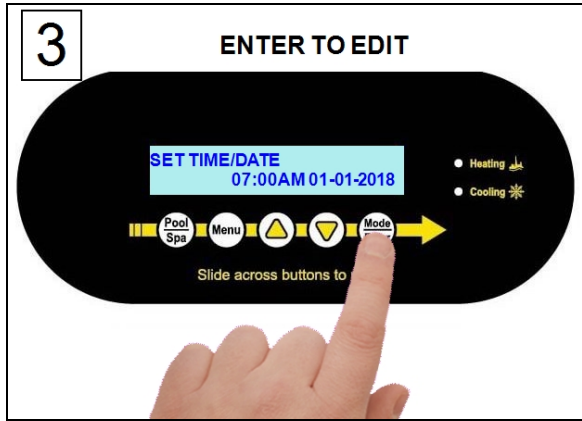
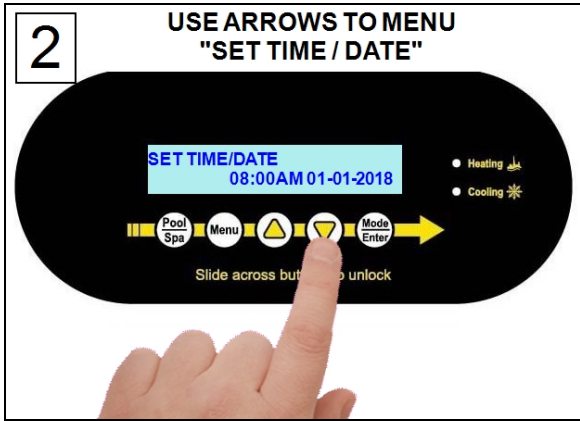

## 1.6.b Using Entry Code to Access Heat Pump

If a user entry code has been enabled in the user menu, an entry code will be required to access heat pump options.

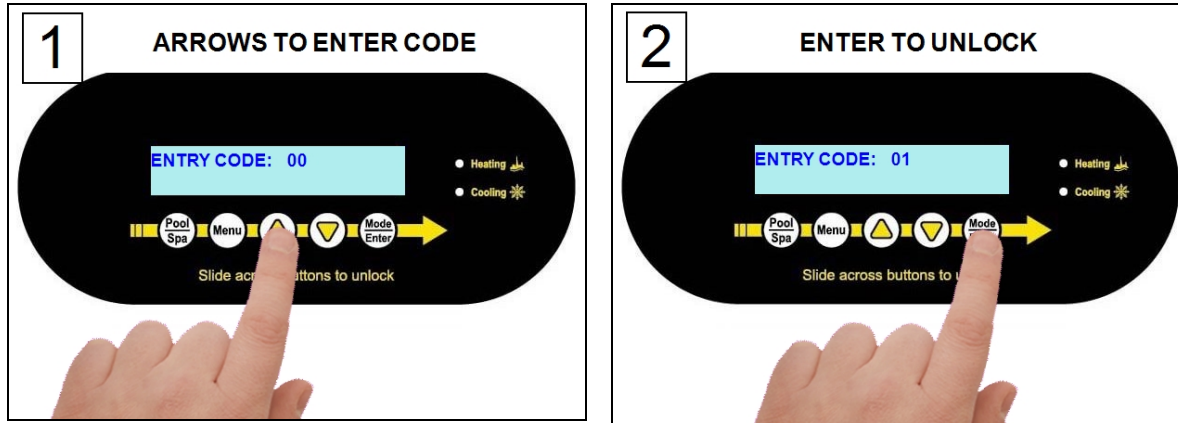

### PLEASE NOTE -

- If the entry code has been misplaced, the heat pump will need to be reset to factory defaults.
- After three minutes of inactivity, the heat pump's sleep mode will activate. See "Wake Up Heat Pump" on page 3.

## 1.6.c Setting Entry Code Option

The entry code feature can prevent unauthorized temperature adjustments. This feature initiates after the heat pump goes into the sleep mode for the first time.

### NOTICE

Failure to heed the following may result in damage to equipment.

- **Before enabling the entry code feature, be sure to record the code.** If lost, the heat pump will require a program reset to regain access. This reset may require additional configuration by the installer.

### PLEASE NOTE -

*A heat pump requesting an entry code is different than the control panel's sleep mode. (See Wake Up Heat Pump on page 3 for more information.)*

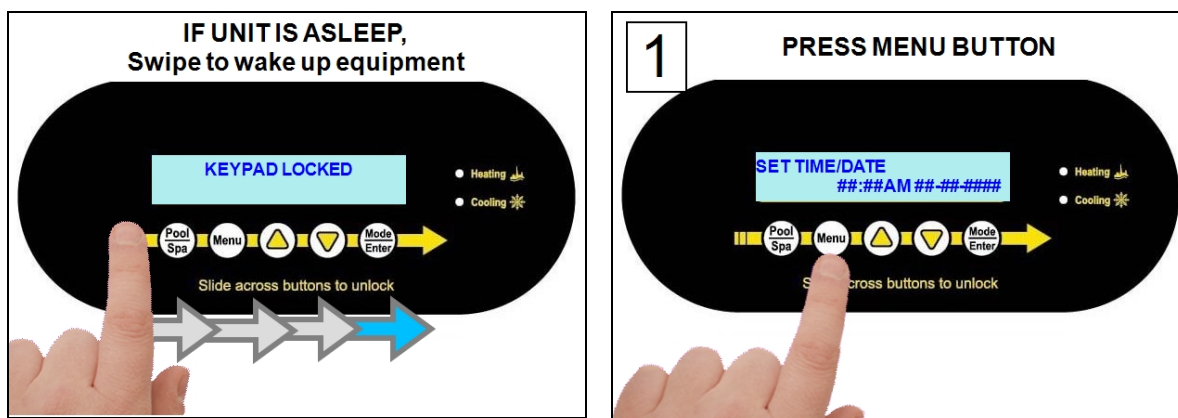



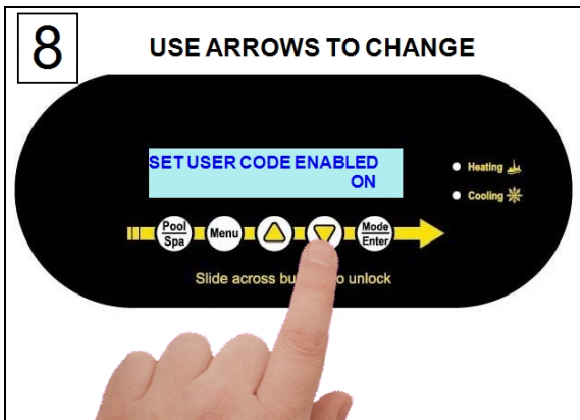
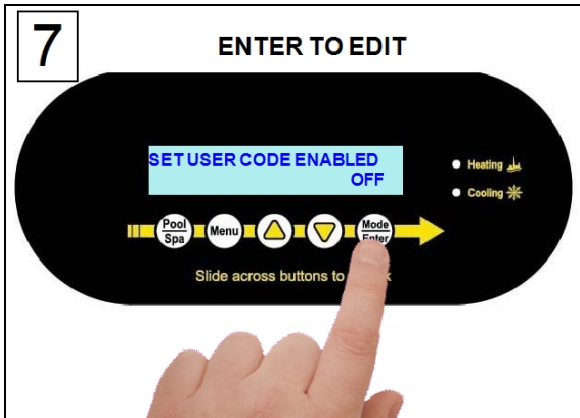
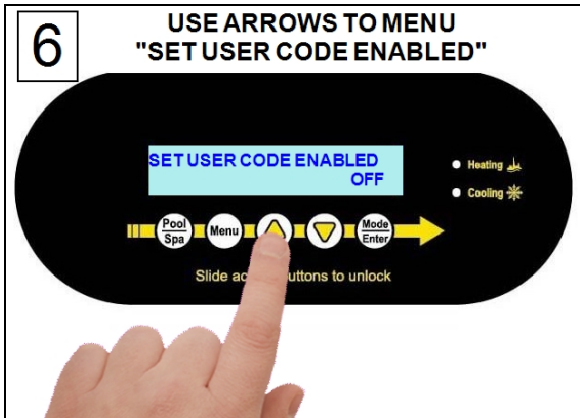
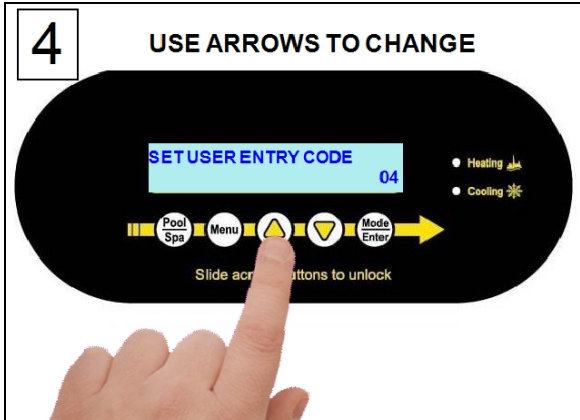
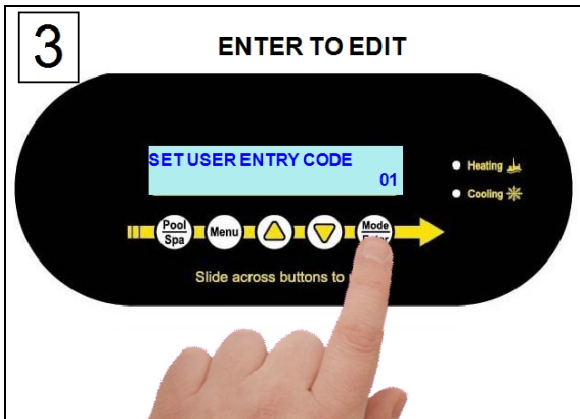
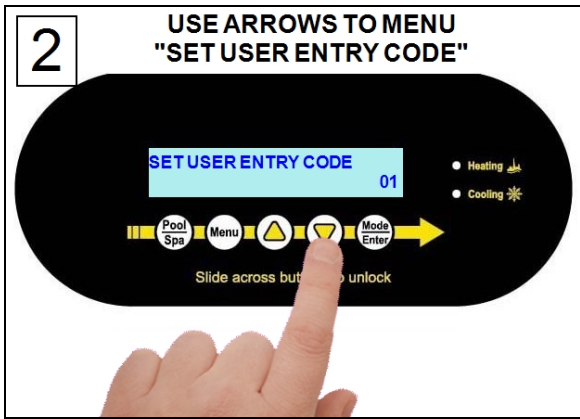

10

### MENU TO EXIT

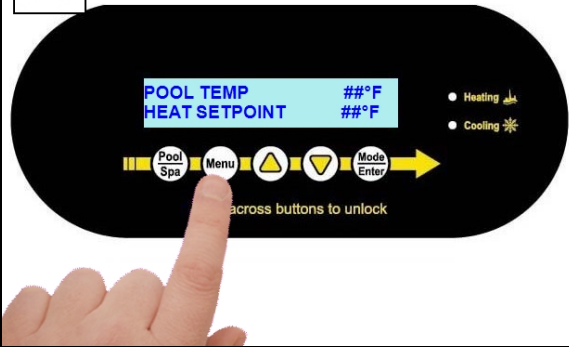

## 1.6.d Disabling Entry Code Option

### PLEASE NOTE -

- If the heat pump displays a **KEYPAD LOCKED** message, the heat pump is in sleep mode. See "Wake Up Heat Pump" on page 3.
- If an entry code has already been activated, the code must be entered before proceeding to disable.

1 - Operation

### IF UNIT IS ASLEEP, Swipe to wake up equipment

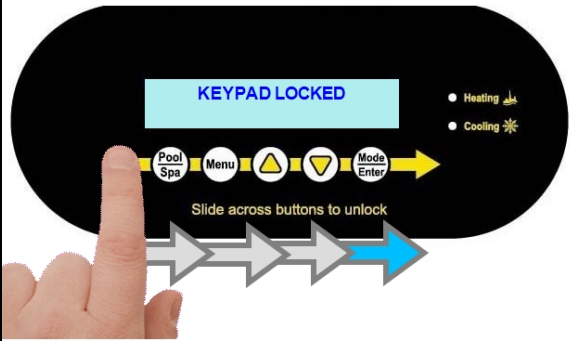

1

### ARROWS TO ENTER CODE



2

### ENTER TO UNLOCK



3

### USE ARROWS TO MENU "SET ENTRY CODE ENABLED"

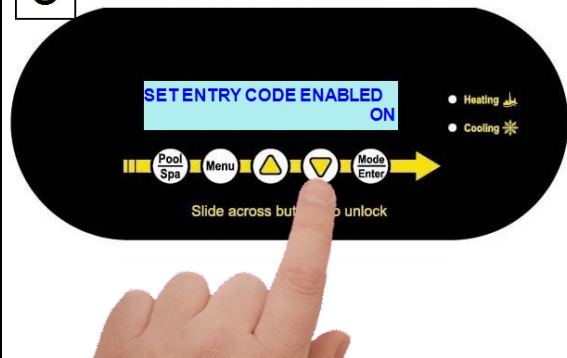

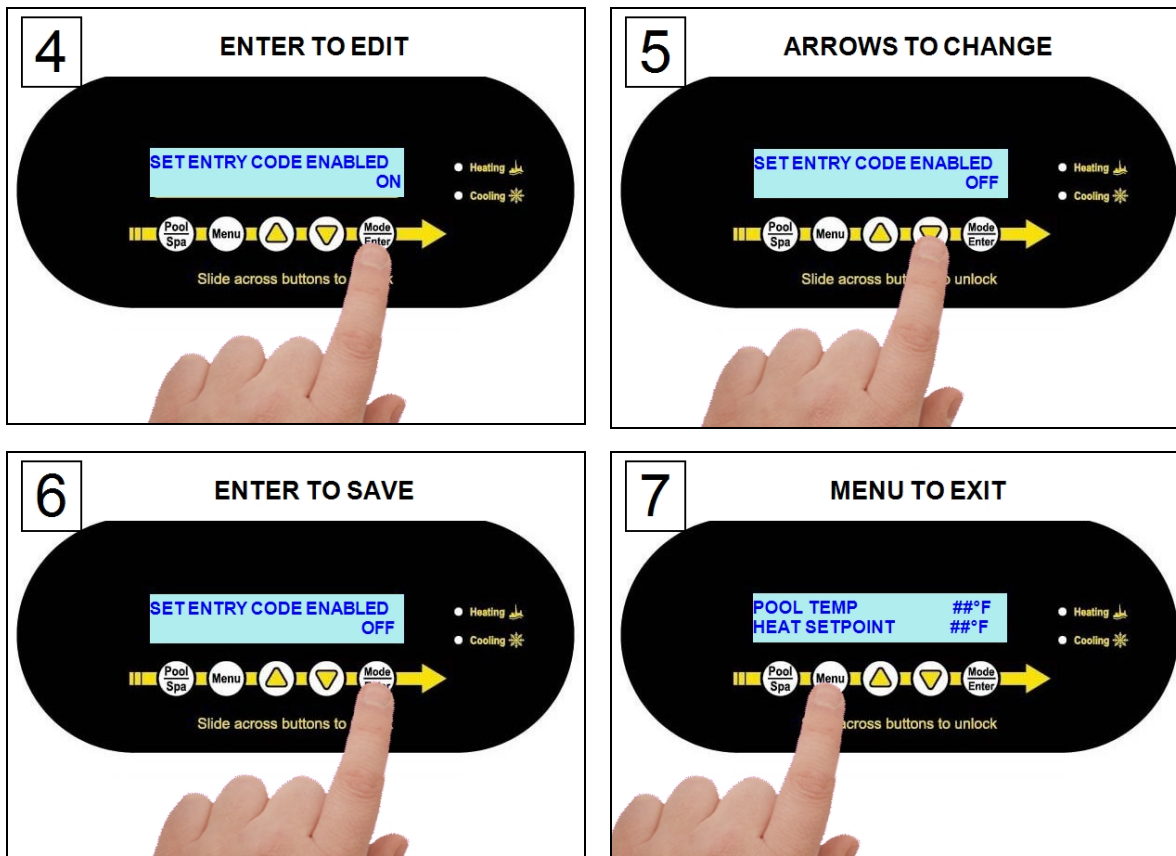

### 1.6.e Configure Variable Speed Compressors

Selected heat pumps have variable speed compressors designed to more quickly and efficiently reach a temperature set point. The compressor's performance can be controlled using a turbo boost mode or two different types of efficiency modes.

#### Turbo Boost

Upon demand, the heat pump's compressor can be set to maximum speed to heat or cool the water quickly. This is regardless of any previously set efficiency mode settings.

- The system will heat or cool the water with the compressor speed set to maximum. This will continue until the set temperature is reached. Then the configured efficiency mode (scheduled or 24-hour) will resume.

#### Efficiency Mode - 24 Hour

When using this mode, the compressor is set to its maximum speed until the temperature set point is reached.

- The compressor speed will then lower to maintain that temperature set point. This will continue as long as there is water flow.
- See "*Set Efficiency Mode to 24 Hour*" on page 14.

## Efficiency Mode - Filtration Schedule

When using this mode, the compressor's speed is set to heat or cool the water within 60% of the circulation pump's filtration time period. This is the highest efficiency operational mode, providing the lowest cost of operation.

- Example - If the filtration period is set from 10:00 am to 8:00 pm, the system attempts to bring the water to set point by 4:00 pm at optimal performance.

### PLEASE NOTE:

*Setting a filtration schedule outside the current circulation pump's schedule will cause an incorrect efficiency mode.*

- See "Set Efficiency Mode to Filtration Schedule" on page 15.

## Turbo Boost

1 - Operation

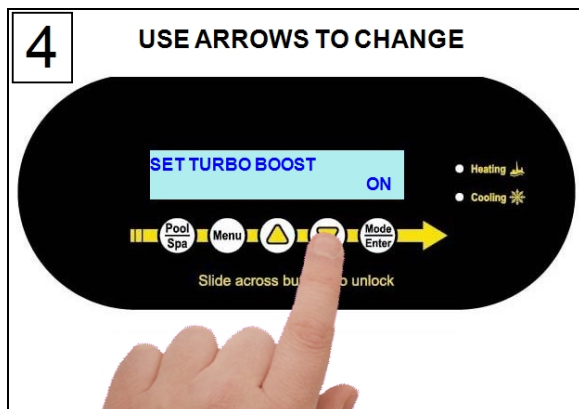
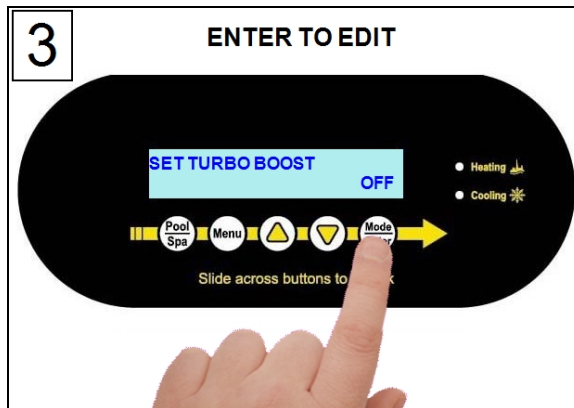
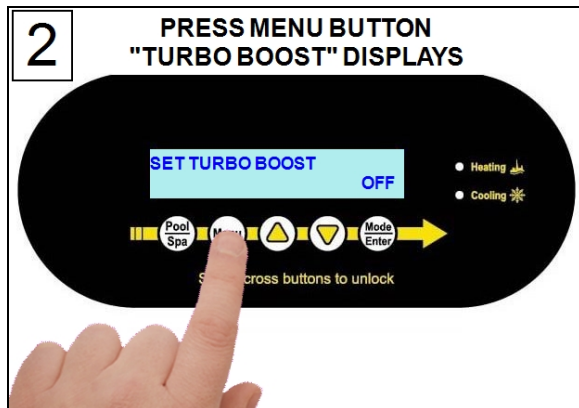
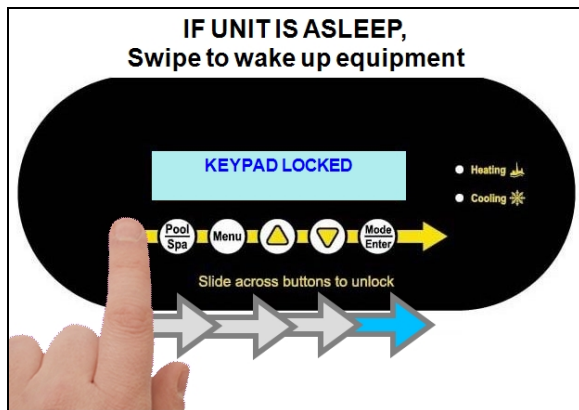

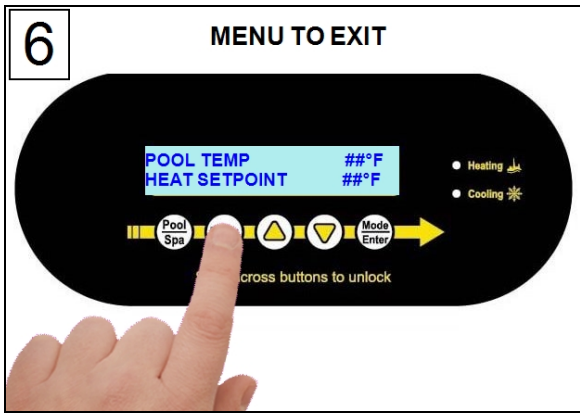

**Set Efficiency Mode to 24 Hour**

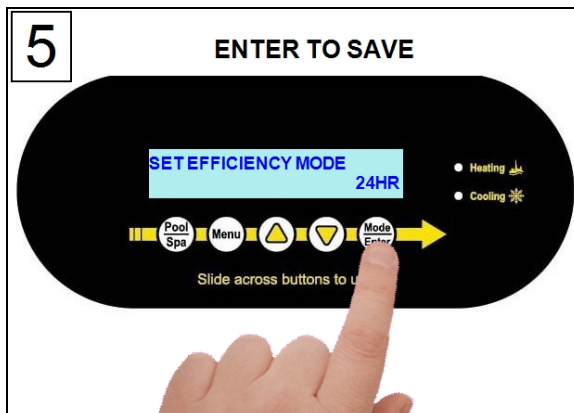
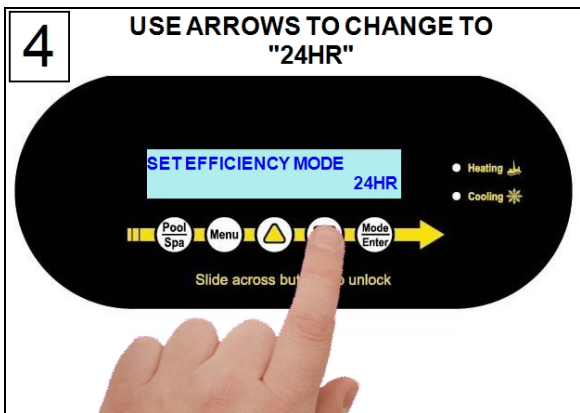
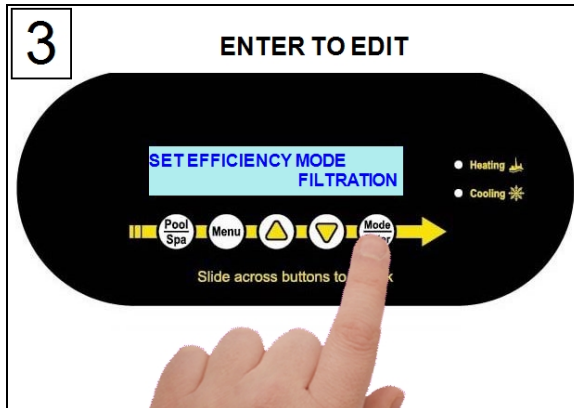
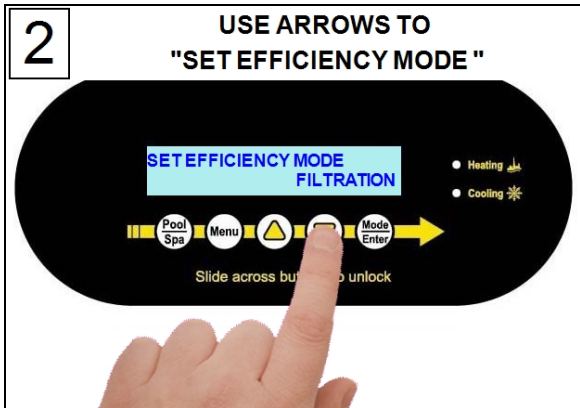
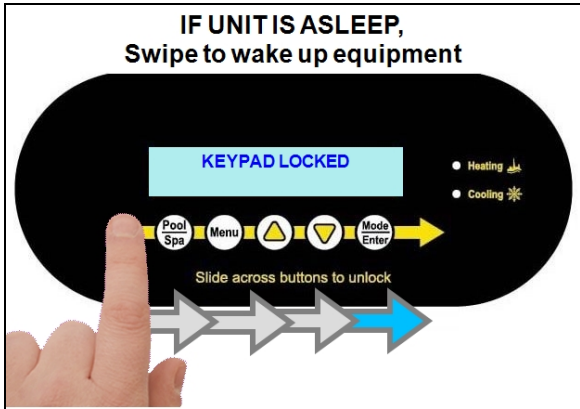



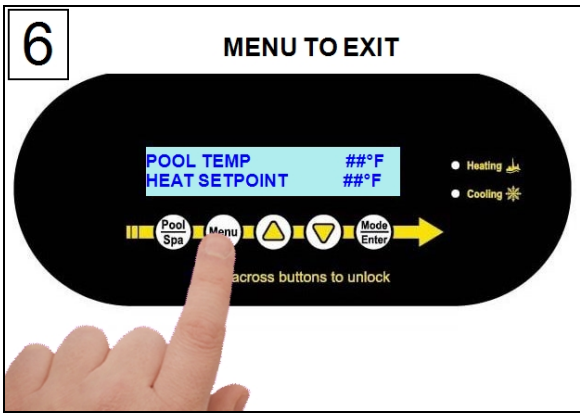

### Set Efficiency Mode to Filtration Schedule

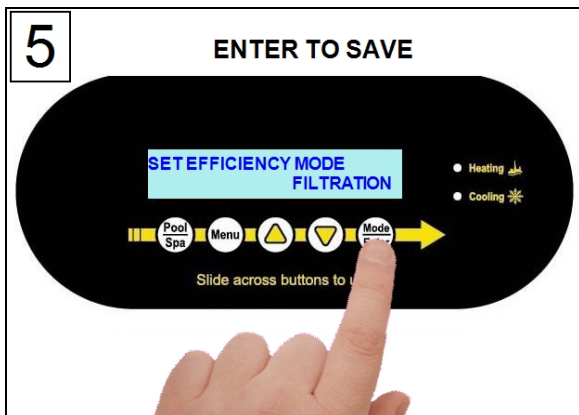
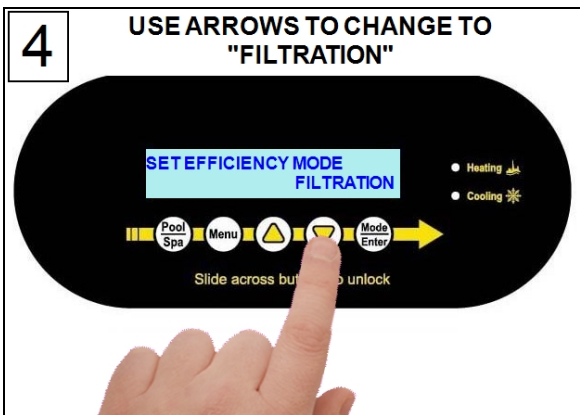
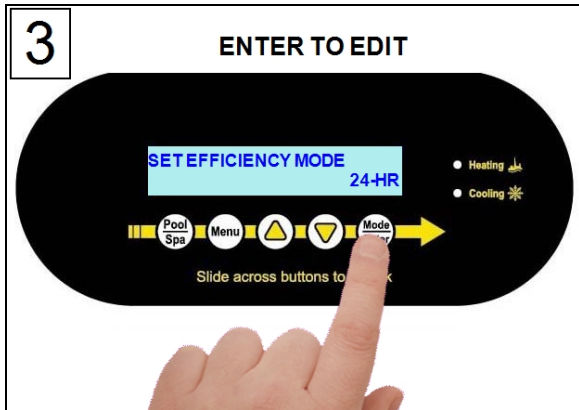
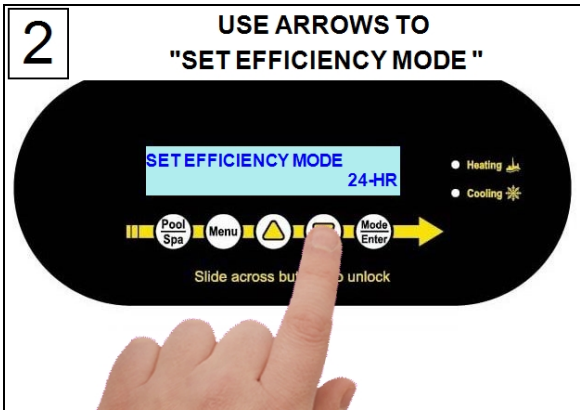
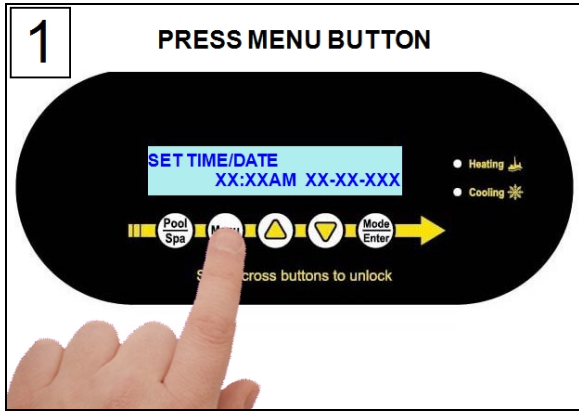
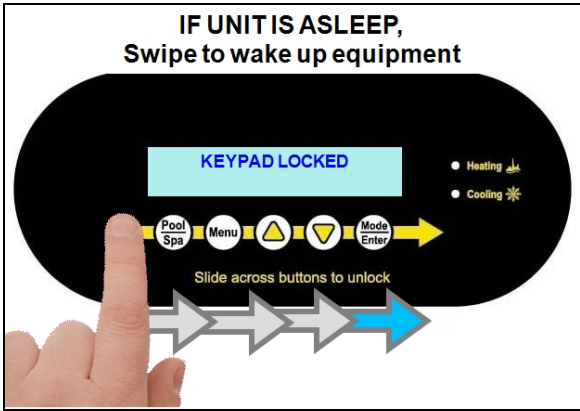

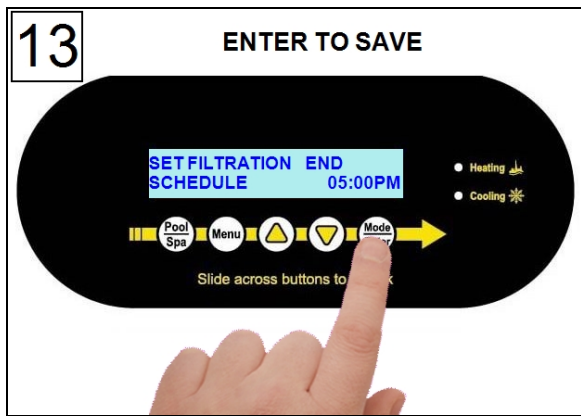
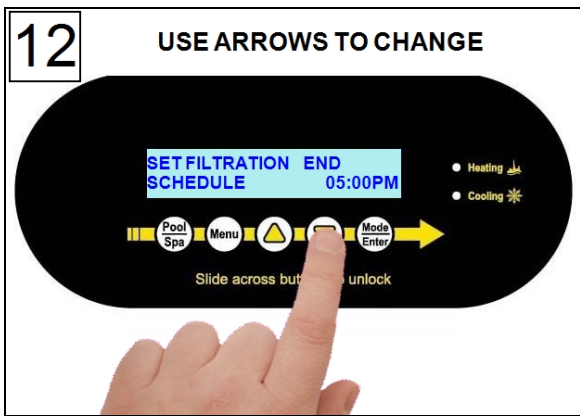
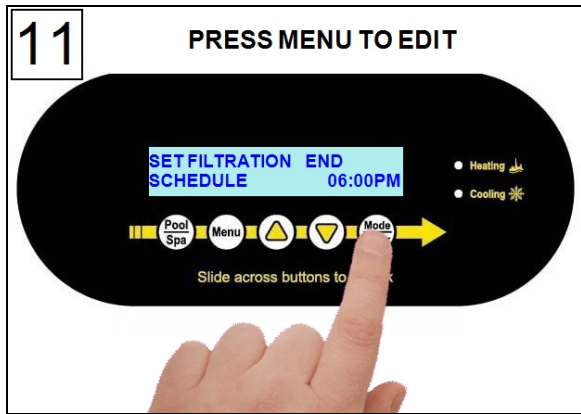
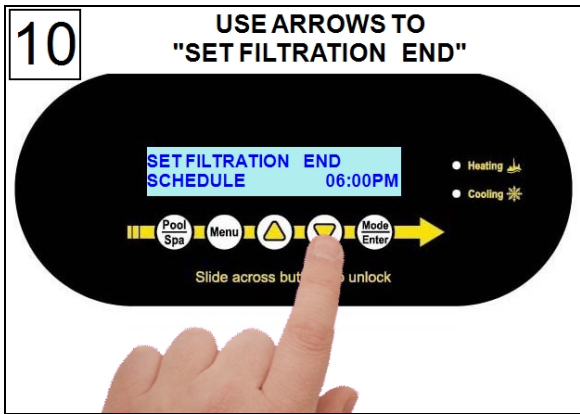
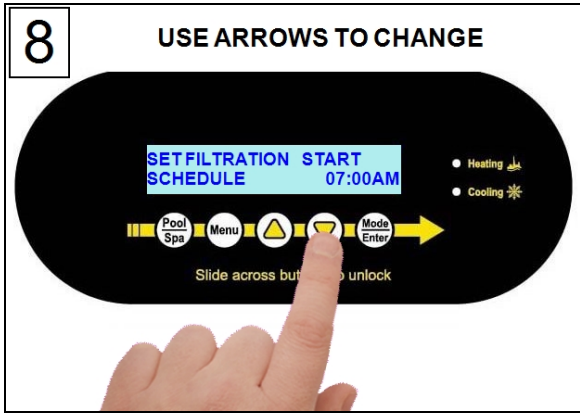
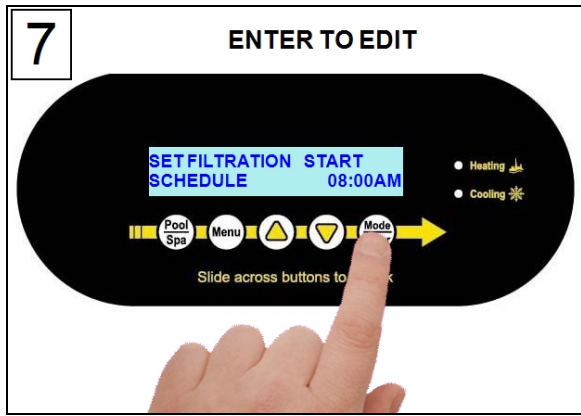
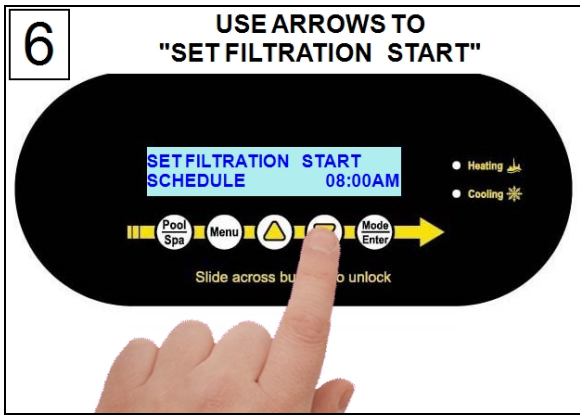

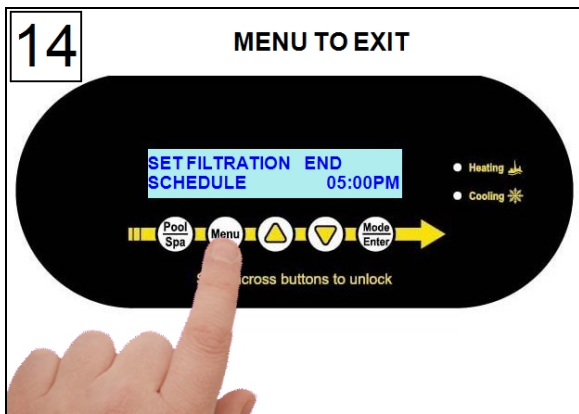

## 1.7 External Equipment

### 1.7.a Operating Heat Pump with a Call Flex

When a Call Flex has been installed and configured for a heat pump, the circulation pump will respond to commands from the heat pump. Confirm with the installer if a Call Flex accessory has been installed on the system. See "*Call Flex Accessory (# 0030-LEDS)*" on page 54.

- If installed, the operator has the option of changing how this accessory works using either "CALL" mode, "FLEX" mode, or "OFF" (Default).

#### Using Call Mode:

When the accessory is in CALL (or override) mode, the circulation pump will be set to periodically activate. This allows the heat pump to sample the water temperature.

- The default is 2 hours between each activation.
- The water temperature will be sampled for 30 seconds.
- If the water temperature has fallen below the set temperature, the circulation pump will allow the heat pump to operate until the set temperature is reached.

#### Using Flex Mode:

When the accessory is in FLEX (or extend) mode, the heat pump will start to heat if the set temperature is lower than the water temperature and the heat pump has water flow. *The circulation pump does not automatically activate in this mode.*

- If the desired water temperature has not been met by the end of the circulation pump's schedule, the normal "time-off" setting will be overridden.
- The circulation pump will continue to operate until the set temperature has been met.
- The circulation pump will then deactivate until the next normally scheduled start time.



## Configure for Call mode:

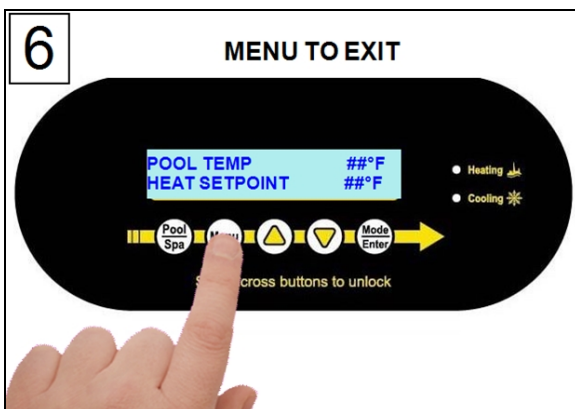
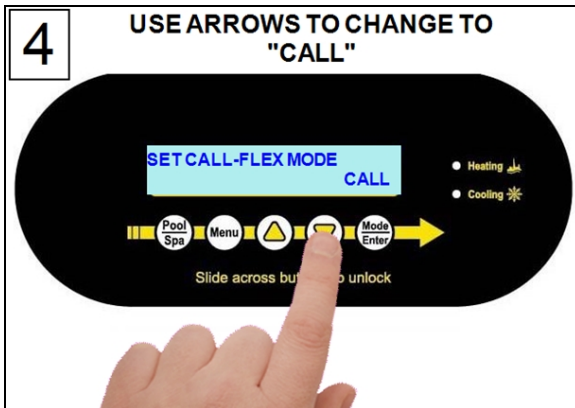
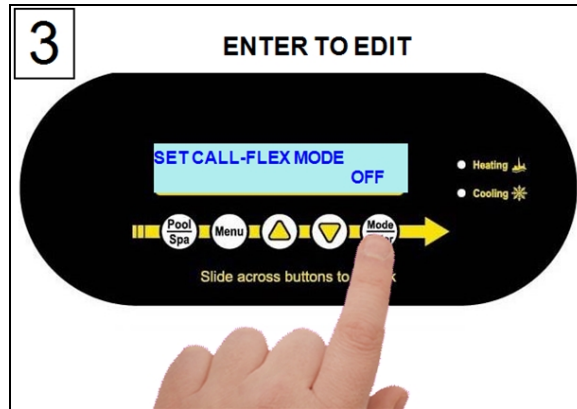
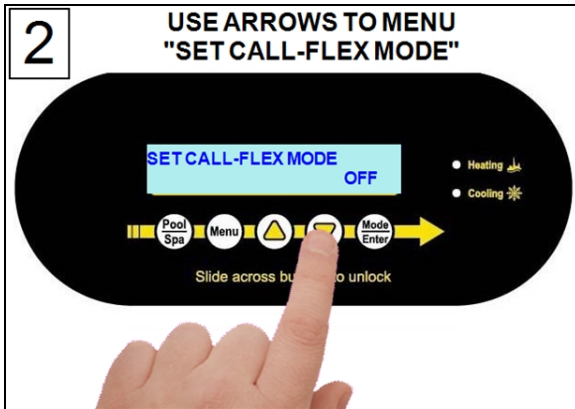
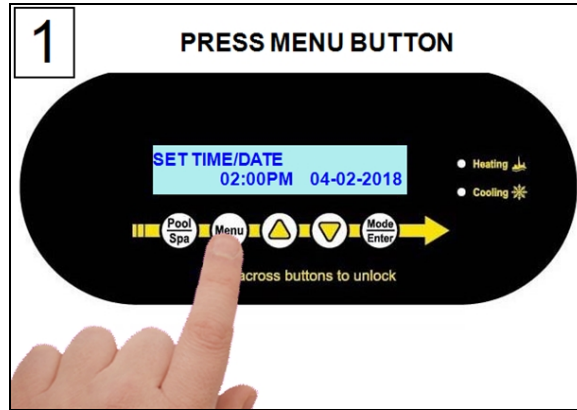
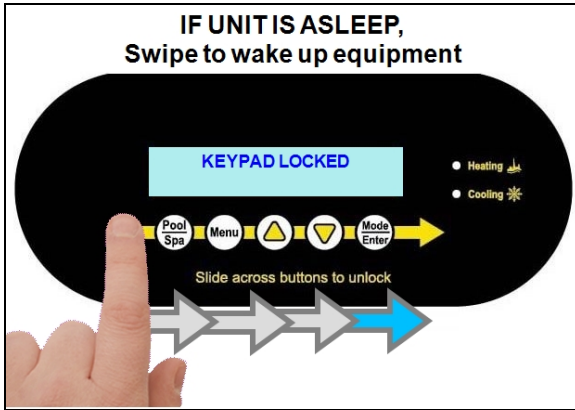

# Configure for Flex mode:

1 - Operation

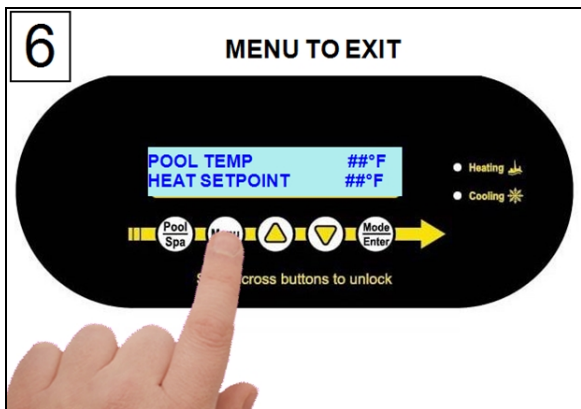
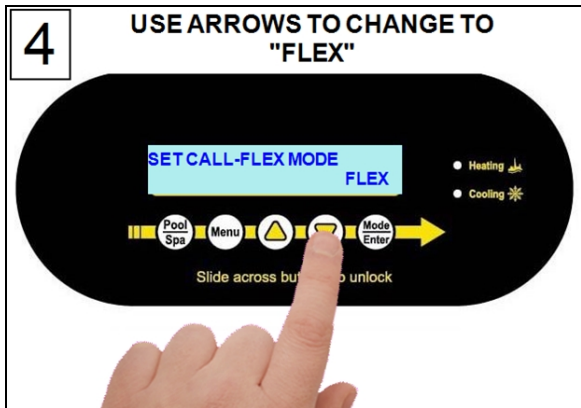
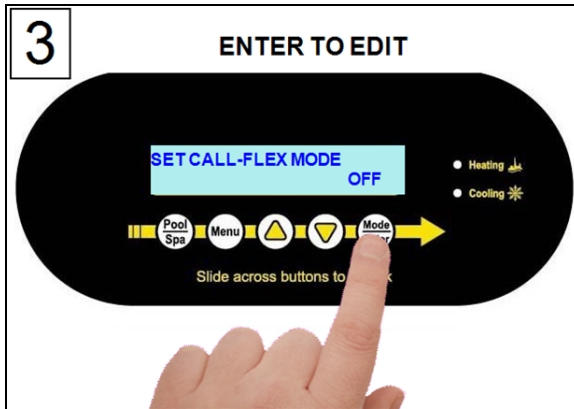
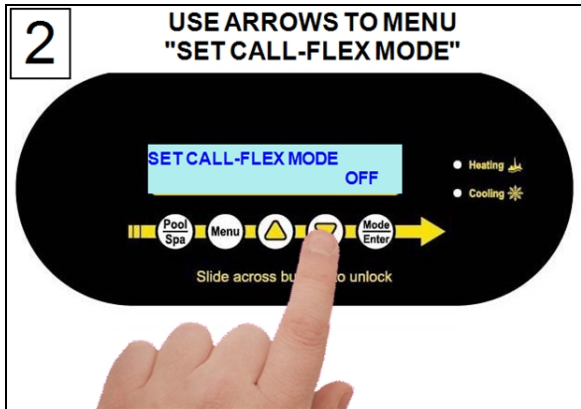
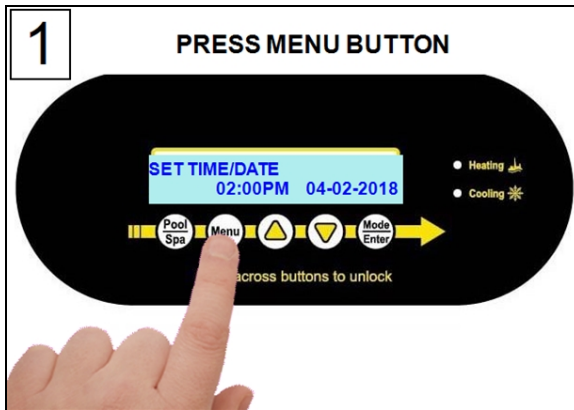
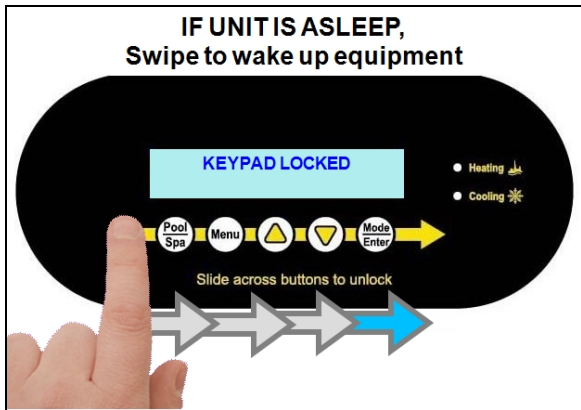

### 1.7.b Operating Heat Pump (With an External Controller)

If the display indicates the unit is under remote control, an external control device has been configured to control the heat pump. See the external control device manual. Or contact installer or manufacturer of that device.

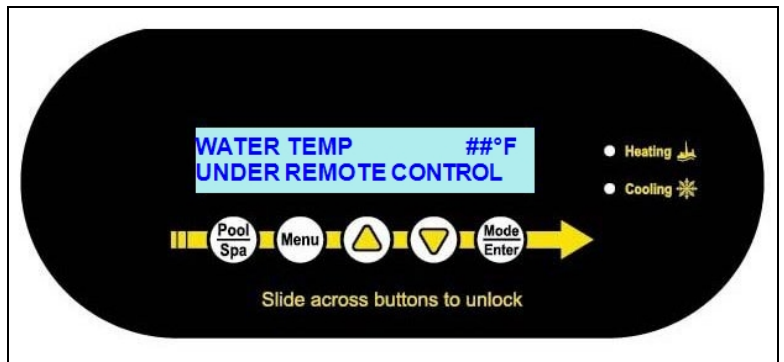

**PLEASE NOTE:**

*When using a SMART external control device, the time-out and service modes will deactivate the Heat Pump.*

### 1.7.c Operating Heat Pump (With an External Flow Switch)

When an external flow switch has been installed and enabled, the heat pump will automatically switch from pool to spa temperature settings when there is flow through the external flow switch. The "Pool/Spa" button will be disabled when this device is configured in the system.

Confirm with the installer if an external flow switch has been installed on the system.

### 1.7.d Operating Heat Pump (With a Gas Back-Up)

If a gas backup heater is installed, it will be configured in one of two modes by the installer (Scheduled mode or 24-hour mode). This affects how the heater operates.

**PLEASE NOTE -**

*Gas backup **modes** are only available when the ambient air temperature is below 60° F. See "Using Gas Boost" on the next page for an exception.*

#### Scheduled Mode

*When heating the Pool:*

- The heat pump will operate for one hour. Then a calculation is made on how fast the water temperature is rising (a rate of rise).
- If an insufficient amount of time is provided for the heat pump to heat the water, the gas backup heater will be activated.
- When the set temperature has been reached, the gas heater will deactivate.
- The heat pump will continue to maintain the water temperature.

*When heating the Spa:*

- If the water temperature is lower than 2° F (1.1° C) below the set temperature, and the ambient air temperature is below 60° F (15.6° C), the gas heater will activate.
- When the set temperature has been reached, the gas heater will deactivate.
- The heat pump will continue to maintain the water temperature.

## 24 Hour Mode

- This mode is usually used when the circulation pump runs continuously.
- The gas heater will activate when the water temperature falls 2° F (1.1° C) below the set temperature and the ambient air temperature is below 60° F (15.6° C).
- When the set temperature is reached, the gas heater deactivates. The heat pump then maintains the water to the set temperature. If the water temperature again falls 2° F (1.1° C) below the set temperature, the gas backup will reactivate.

### d.1 Using Gas Boost

When a gas backup heater is installed, the user has the option of using a gas boost to heat the water quicker.

- This option is available regardless of the gas heater's configuration mode set by the installer (Scheduled Mode or 24 Hour Mode).
- When the set temperature is reached, the gas heater will deactivate. The heat pump then continues to maintain the temperature set point. The gas heater will revert to its normal mode (either 24-hour or scheduled).

#### **PLEASE NOTE -**

*The "Gas boost" option is available regardless of outside air temperature.*

*This option, however, will only appear in the user menus when the heat pump is actively heating the water.*

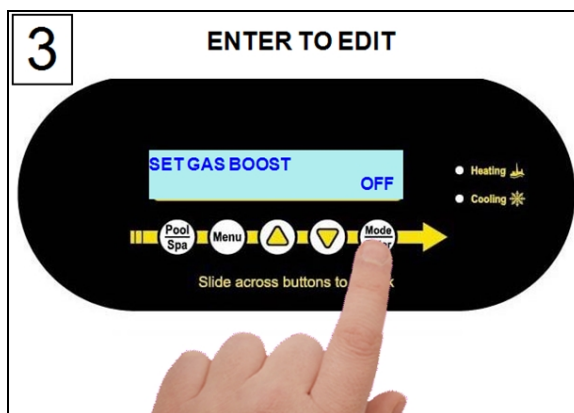
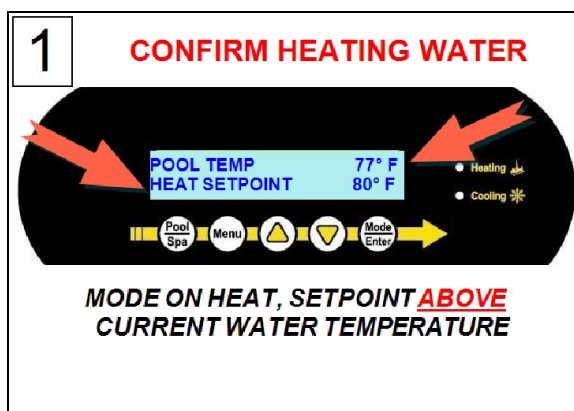
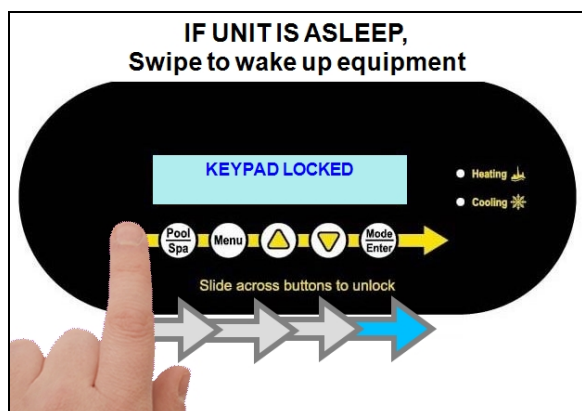

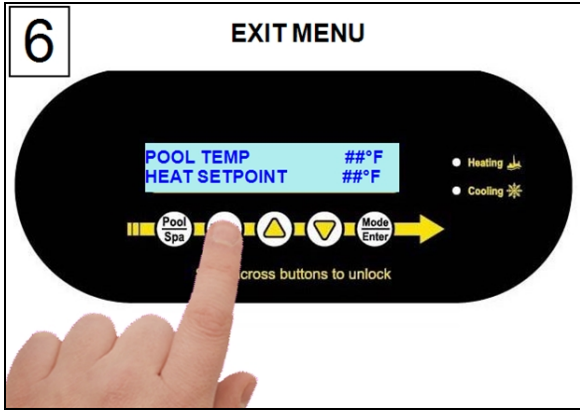
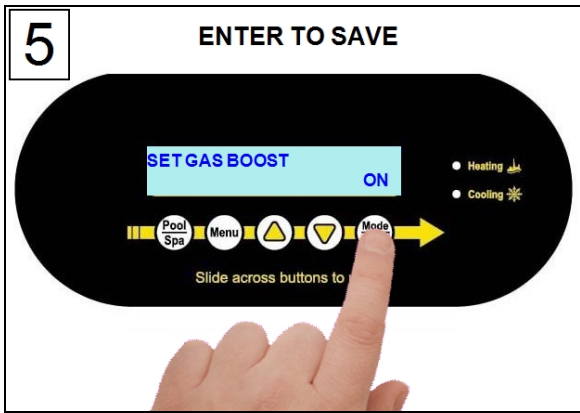
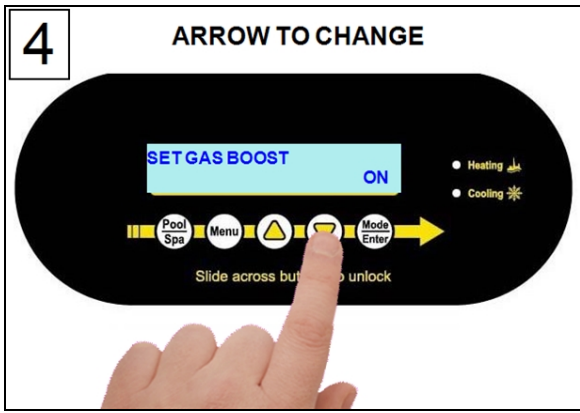

**1.7.e Operating Multiple Connected Heat Pumps**

Each heat pump will indicate whether it is a primary or secondary unit on the display. Changes in mode and operation are made on the primary heat pump only.

- The primary heat pump will automatically start and stop the secondary heat pumps in a timed and controlled sequence.

Primary Heat Pump

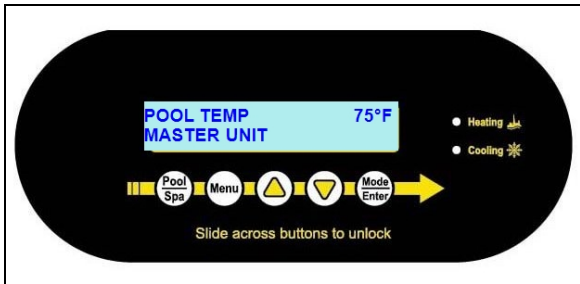

Secondary Heat Pump 01

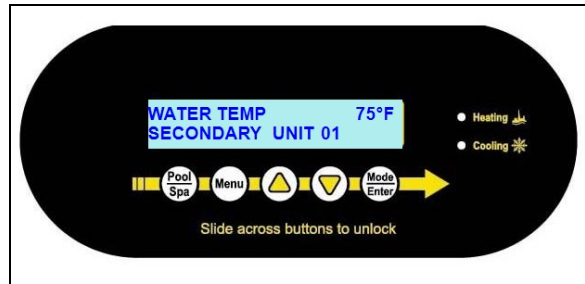

Secondary Heat Pump 02

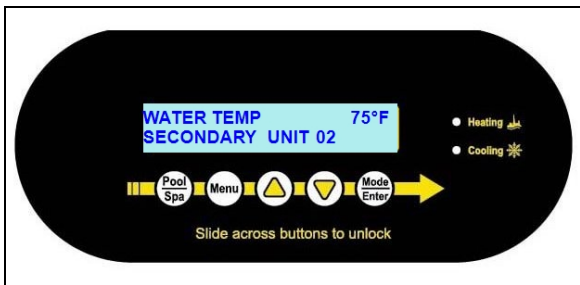

Secondary Heat Pump 03

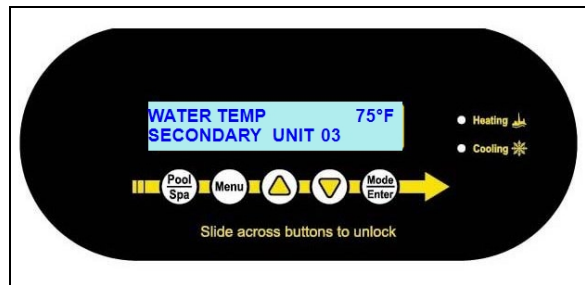

## 2 - Maintenance

### IN THIS SECTION:

2.1 Water Chemistry .....	23
2.2 Cleaning Equipment .....	24
2.3 Clearances .....	25
2.4 Irrigation and Storm Run-Off .....	26
2.5 Water Flow Rates .....	26
2.6 Adjusting Water Flow Using $\Delta T$ (Delta-T) .....	27
2.7 Planned Maintenance .....	30
2.8 Winterizing .....	31

### 2.1 Water Chemistry

Check water chemistry regularly and maintain within recommended levels. Standards vary in different residential and commercial applications. Follow all local applicable codes.

#### NOTICE

Failure to heed the following may result in damage to equipment.

- Do not allow water to flow through the heat pump when refinishing or acid washing a pool. Use an installed bypass to route water away from the heat pump or deactivate the filter pump.
- To avoid damage to equipment, monitor and maintain chemistry within recommended levels.

#### CHEMISTRY LEVEL CHART (RESIDENTIAL)

CHEMICAL	POOLS	SPAS
<b>Chlorine</b>	1.0 – 3.0 ppm (1 – 3 mg/L)	3.0 – 5.0 ppm (3 – 5 mg/L)
<b>Bromine</b>	2.0 – 6.0 ppm (2 – 6 mg/L)	2.0 – 6.0 ppm (2 – 6 mg/L)
<b>Cyanuric Acid</b>	30 – 50 ppm (30 – 50 mg/L)	30 – 50 ppm (30 – 50 mg/L)
<b>pH</b>	7.4 – 7.6	7.4 – 7.6
<b>Total Alkalinity</b>	80 – 120 ppm (80 – 120 mg/L)	80 – 120 ppm (80 – 120 mg/L)
<b>Calcium Hardness</b>	200 – 400 ppm (200 – 400 mg/L)	150 – 250 ppm (150 – 250 mg/L)
<b>Total Dissolved Solids*</b>	0 – 1500 ppm (0 – 1.5 g/L)	1500 (1.5 g/L) ppm above start-up of total dissolved solids in spas

\* Salt from a chlorine generator is not included in Total Dissolved Solids.



## 2.2 Cleaning Equipment

Cleaning and polishing the heat pump regularly can protect its appearance and longevity. More frequent servicing may be required for heat pumps located in sandy or coastal areas where sand and salt spray can damage equipment.

### WARNING

Failure to heed the following may result in injury or death.

- Possible electric shock hazard - Deactivate power to all electrical devices on the pad when washing heat pump. Do not restore electrical power until equipment is completely dry.

### NOTICE

Failure to heed the following may result in damage to equipment.

- Do not use a pressure cleaner to wash the heat pump. Damage to heat pump components may result. If using a hose-end spray nozzle adjust the spray pattern to low strength only.
- Do not spray water directly into the interior of the heat pump; damage to components may result.
- Do not use chemicals on the display panel.

## Cleaning

1. Wash cabinet using a low-pressure water hose. A high-pressure water stream will cause damage to the aluminum fins of the heat pump. This damage is not covered under the product warranty.
2. While the heat pump is still wet, use an approved cleaning agent to clean the exterior of the heat pump. **Do not use chemicals on the display panel.**
3. Use a detergent-dampened cloth to wipe the heat pump's exterior cabinet.
4. Flush all exterior with fresh water using a low-pressure water hose.
5. Dry the cabinet using a soft cloth being careful not to damage fins.

APPROVED CLEANING AGENTS*
Fantastic®
Formula 409®
Cascade®
All Power Plain Detergent (3% Solution)

Table 1 - Cleaning Agents

- \* The trademarks used in approved cleaning agents are the property of their owners and are not related to AquaCal®.

## Polishing

1. Polish the heat pump's cabinet panels using an approved polishing agent and following the manufacturer's instructions. **Do not use chemicals on the display panel.**
2. Rinse the heat pump panels with fresh water, wipe, and buff panels using a dry soft cloth.
3. Allow heat pump interior and surrounding equipment to "air-dry" for several hours prior to restoring electrical power.

### APPROVED POLISHING AGENTS\*

Simoniz® Wax

Glo-Coat®

Armor All® Protectant

Table 2 - Polishing Agents

- \* The trademarks used in approved polishing agents are the property of their owners and are not related to AquaCal®.

## 2.3 Clearances

- Proper air circulation is required for the heat pump to operate efficiently. The following diagrams show the minimum clearances required for the proper operation of the heat pump.
- Avoid storing chemical containers near the heat pump. The chemicals can cause equipment damage.
- Avoid placing objects near or on top of the heat pump. This includes shrubbery and lawn furniture. These objects will reduce performance and efficiency and hinder maintenance access.

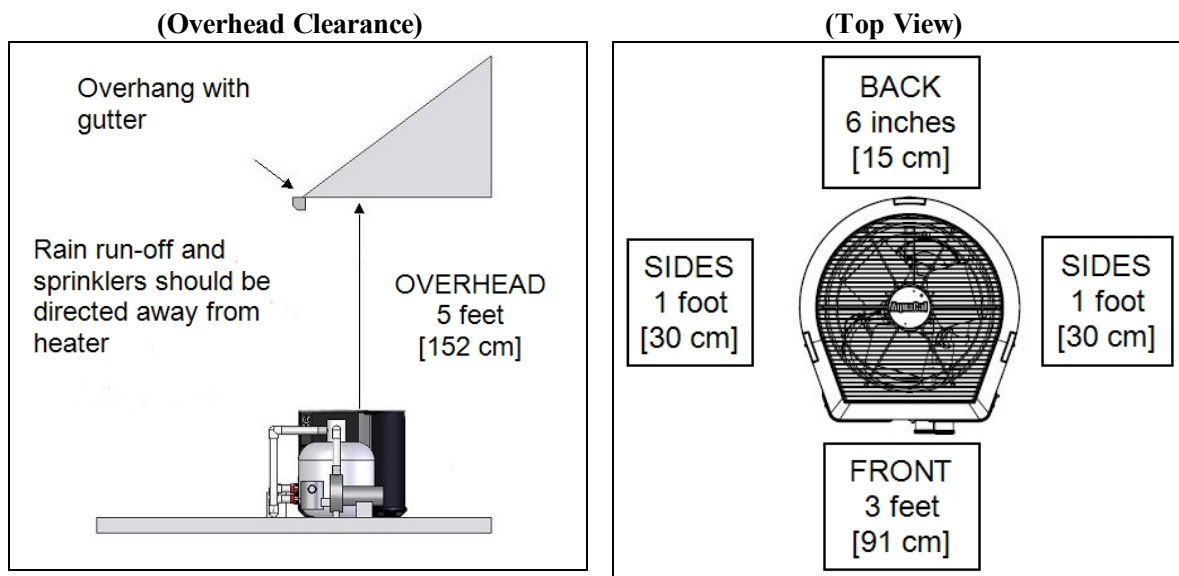



(Top View)  
TropiCal® T170

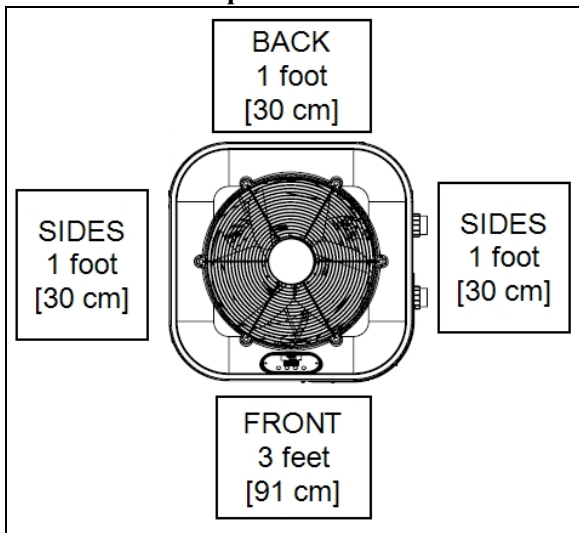

## 2.4 Irrigation and Storm Run-Off

- Irrigation water may damage heat pump components. Direct irrigation water away from the heat pump.
- The heat pump will withstand normal rainfall. Do not allow a roof slope to direct rainwater onto the heat pump. Have a gutter installed on the roof edge to direct this water away from the heat pump. Or install the heat pump in another location.

## 2.5 Water Flow Rates

Maintain water flow rates as indicated. Please note, these specifications relate to the heat pump only. Code-specified whole system turnover rates must be satisfied.

### NOTICE

Failure to heed the following may result in damage to equipment.

- Water flow exceeding maximum flow rates will negatively affect the total pool filtration performance and may damage the heat pump. This will not be covered under the equipment warranty.

MODEL	HEAT EXCHANGER TYPE	FLOW RATES	
		MINIMUM	MAXIMUM
SQ120R	Titanium ThermoLink®	30 GPM (113.6 L/min)	70 GPM (265 L/min)
SQ125	Titanium ThermoLink®	30 GPM (113.6 L/min)	70 GPM (265 L/min)
SQ145	Titanium ThermoLink®	30 GPM (113.6 L/min)	70 GPM (265 L/min)
SQ150VS	Titanium ThermoLink®	30 GPM (113.6 L/min)	70 GPM (265 L/min)
SQ166R	Titanium ThermoLink®	30 GPM (113.6 L/min)	70 GPM (265 L/min)
SQ225	Titanium ThermoLink®	30 GPM (113.6 L/min)	70 GPM (265 L/min)
T035	Titanium Tube-in-Tube	20 GPM (75.7 L/min)	45 GPM (170 L/min)
T055	Titanium Tube-in-Tube	20 GPM (75.7 L/min)	45 GPM (170 L/min)
T075	Titanium Tube-in-Tube	20 GPM (75.7 L/min)	45 GPM (170 L/min)
T090	Titanium ThermoLink®	30 GPM (113.6 L/min)	70 GPM (265 L/min)
T115	Titanium ThermoLink®	30 GPM (113.6 L/min)	70 GPM (265 L/min)
T135	Titanium ThermoLink®	30 GPM (113.6 L/min)	70 GPM (265 L/min)

MODEL	HEAT EXCHANGER TYPE	FLOW RATES	
		MINIMUM	MAXIMUM
T170	Titanium Tube-in-Tube	30 GPM (113.6 L/min)	70 GPM (265 L/min)
TC500	Titanium Tube-in-Tube	20 GPM (75.7 L/min)	45 GPM (170 L/min)
TC1000	Titanium ThermoLink <sup>®</sup>	30 GPM (113.6 L/min)	70 GPM (265 L/min)
TC1500	Titanium ThermoLink <sup>®</sup>	30 GPM (113.6 L/min)	70 GPM (265 L/min)

**PLEASE NOTE -**

If minimum flow rates are not met, heat pump performance is reduced and performance will suffer. Internal safety devices may deactivate the heat pump with the following errors:

- **HIGH PRESSURE FAULT**
- **HP5 SYSTEM LOCKOUT**
- **LOW PRESSURE FAULT**
- **LP5 SYSTEM LOCKOUT**

- Operate water filtration devices per manufacturer's specifications. Dirty filters can cause a reduction of water flow to the heat pump. An increase of 7-10 psi (48 to 69 kPa) higher than the clean filter pressure typically reduces flow rates. This requires the filter to be cleaned or back-washed.
- Keep baskets free of debris. A large quantity of debris in the pump and skimmer baskets can reduce water flow.
- Check for improper valve settings. A partially closed valve after the filter, or a full-open bypass around the heat pump, will cause insufficient water flow through the heat pump.
- The maximum static pressure (or operating pressure) is 50 psi (345 kPa). These specifications relate to the heat pump only.
- Code-specified whole system turnover rates must be satisfied.

## 2.6 Adjusting Water Flow Using $\Delta T$ (Delta-T)

The Delta-T is the temperature difference between the water temperatures entering and leaving the heat pump. The equipment can be fine-tuned for maximum performance by balancing water flow rates to maintain an ideal  $\Delta T$ .

**The adjustment procedure must be completed with the unit in heating mode.**

- Installed temperature ports are required to perform the following procedures.
- These ports are typically located on the pool in and pool out water lines approximately six inches away from the heat pump.

**PLEASE NOTE -**

- The installation of temperature ports is required for all commercial applications.
- The installation of temperature ports is strongly recommended for residential installations.
  - See "*Temperature Port Kit (#STK0096)*" on page 55.

**Temperature Port  
(Shown with Probe)**



1. Adjust the thermostat to its lowest setting with the unit in heating mode.
2. Deactivate the water filtration pump.
3. Confirm that the filters leading to the heat pump are clean.
4. Adjust the valves controlling water headed towards the heat pump to the half-open position.
5. Adjust the valves controlling water leading away from the heat pump to a fully open position.
6. Activate the pool water filtration pump.
7. Slowly raise the thermostat temperature until the heat pump activates.
  - After a three-minute delay, the heat pump's compressor will start.
8. With the heat pump running, confirm the filtration pump is operating properly with adequate flow and no short cycling.
9. Wait for water temperatures to stabilize (approximately 5 minutes).
12. Adjust valves in the following order using the temperature chart provided.
  - a. Adjust the valve that controls water exiting the heat pump until the correct temperature differential is achieved. Match the temperature measured with a temperature probe to the chart.
  - b. Wait for water temperatures to stabilize. Then check the temperature again. Re-adjust the valve as needed.
13. Mark valves at these positions for future reference.

HEAT EXCHANGER TYPE	MODEL	TEMPERATURE
Titanium ThermoLink®	SQ120R	3° to 7° F (1.7° C to 3.9° C)
Titanium ThermoLink®	SQ125	3° to 7° F (1.7° C to 3.9° C)
Titanium ThermoLink®	SQ145	3° to 7° F (1.7° C to 3.9° C)
Titanium ThermoLink®	SQ150VS	3° to 7° F (1.7° C to 3.9° C)
Titanium ThermoLink®	SQ166R	3° to 8° F (1.7° C to 4.4° C)
Titanium ThermoLink®	SQ225	4° to 9° F (2.2° C to 5° C)
Tube-in-Tube	T035	1° to 4° F (.5° C to 2.2° C)
Tube-in-Tube	T055	2° to 5° F (1.1° C to 2.8° C)

HEAT EXCHANGER TYPE	MODEL	TEMPERATURE
Tube-in-Tube	T075	3° to 7° F (1.7° C to 3.9° C)
Titanium ThermoLink®	T090	3° to 6° F (1.7° C to 3.3° C)
Titanium ThermoLink®	T115	3° to 7° F (1.7° C to 3.9° C)
Titanium ThermoLink®	T135	4° to 8° F (2.2° C to 4.4° C)
Titanium Tube-in-Tube	T170	3° to 7° F (1.7° C to 3.9° C)
Titanium Tube-in-Tube	TC500	2° to 5° F (1.1° C to 2.8° C)
Titanium ThermoLink®	TC1000	2° to 5° F (1.1° C to 2.8° C)
Titanium ThermoLink®	TC1500	3° to 7° F (1.7° C to 3.9° C)

Table 3 - Temperature Chart

**PLEASE NOTE -**

- Temperature differences are based on pool water temperatures of 69° to 75° F. (20.5° to 23.8° C)
- For water temperatures outside this range, contact AquaCal®. See "*Contacting AquaCal AutoPilot, Inc.*" on page 1.

## 2.7 Planned Maintenance

An annual inspection and maintenance program is strongly recommended starting no later than one year after installation of the heat pump. In harsh environments or coastal areas, a bi-annual inspection is recommended. See the recommended inspection checklist.

AquaCal® can perform this service in limited areas. Contact Customer Support for more information.

### DANGER

Failure to heed the following will result in injury or death.

- RISK OF ELECTRICAL SHOCK FROM ENERGY STORED IN CAPACITORS - MODELS EQUIPPED WITH VARIABLE FREQUENCY COMPRESSOR DRIVES STORE ELECTRICITY EVEN AFTER THE POWER HAS BEEN DEACTIVATED AT THE POWER BREAKER. ***Wait for 2 minutes after the shut down of equipment before servicing.***
- Deactivate power while routing wiring to control board.
- Follow all National Electric Codes (NEC) and/or State and Local guidelines.

### WARNING

Failure to heed the following may result in injury or death.

- Annual inspection and service must be performed by a qualified heat pump specialist in order to prevent physical injury or damage to equipment. For tasks requiring handling refrigerant, an HVAC license is required.

#### Recommended Inspection Checklist:

1. Clean Evaporator Coil (As Applicable)
2. Clean Condenser Coil (As Applicable)
3. Check Contactor Points
4. Check Fan Capacitor Values
5. Check Fan Blade Clearances
6. Clean Heat Pump Cabinet
7. Check Flow / Pressure Switch
8. Apply Rust Inhibitors (As applicable)
9. Verify / Check Air Flow Delta-T
10. Verify / Check Water Flow Delta-T
11. Check Fan Motor Amperage Draw
12. Check and Clear Condensate Drains
13. Check Compressor Capacitor Values
14. Check Compressor Amperage Draw
15. Check Internal Electrical Connections
16. Check Operating Refrigerant Pressures (As Applicable)
17. Check Ambient and Water Temperature Sensors
18. Check Proper Line and Control Voltage to Unit
19. Identify Insect and Rodent Issues with Unit
20. Identify Environmental Conditions of Concern (Run-Off, Sprinklers, etc.)
21. Perform Operating Orientation (As Applicable)

## 2.8 Winterizing

Failure to properly winterize the heat pump as needed may result in serious equipment damage.

### DANGER

Failure to heed the following will result in injury or death.

- RISK OF ELECTRICAL SHOCK FROM ENERGY STORED IN CAPACITORS - MODELS EQUIPPED WITH VARIABLE FREQUENCY COMPRESSOR DRIVES STORE ELECTRICITY EVEN AFTER THE POWER HAS BEEN DEACTIVATED AT THE POWER BREAKER. *Wait for 2 minutes after the shut down of equipment before servicing.*
- Deactivate power while routing wiring to control board.
- Follow all National Electric Codes (NEC) and/or State and Local guidelines.

### WARNING

Failure to heed the following may result in injury or death.

- Deactivate all electrical power to heat pump before performing hard freeze procedures.

### NOTICE

Failure to heed the following may result in damage to equipment.

- Failure to winterize heat pump may result in serious equipment damage. Freeze damage is not covered under the heat pump warranty.
- While the plumbing connections are in the winterized condition (not fully tightened), it is imperative that water not run through the heat pump. Loss of water through loose plumbing connections may result in damage to circulation pump, pool and spa structures, and other equipment.

### Light Freeze Conditions

A light freeze is when the ambient air temperature falls below 32 degrees Fahrenheit (0° C) for less than 8 hours. Typically during light freeze conditions circulating (or moving) water will not freeze. Temporarily activate the filter pump for continuous operation during light freeze conditions.

### Hard Freeze Conditions

A hard freeze is when the ambient air temperature falls below 32 degrees Fahrenheit (0° C) for more than 8 hours. In areas where this condition is prevalent and sustained, the heat pump MUST be winterized for hard freeze conditions. Follow the correct procedure depending on the type of heat exchanger found in the heat pump.

#### Confirm Exchanger Type:

1. Deactivate all electrical power to heat pump.
2. Deactivate the filter pump.
3. Remove the front access panel.
4. Identify heat exchanger from the illustration(s) in this section.
5. Reinstall front access panel. Then follow the procedure for the appropriate heat exchanger.

### Titanium ThermoLink<sup>®</sup> Exchanger (with no Drain)

6. Disconnect the plumbing to the heat pump at connection unions (removal is counter-clockwise).
7. Allow water to drain completely from the heat pump. Expect to see a lot of water drain out at first, and then a small amount to continue to drain out over a long period.
8. After heat pump has fully drained, partially reconnect plumbing connection unions.
9. Winterizing is complete.
10. When ready to use the heat pump again, hand-tighten connection unions. Reconnect electrical power, and set the operating mode on the heat pump. Activate the filter pump.

No Drain

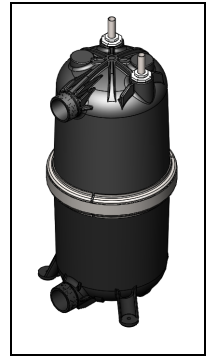

### Titanium ThermoLink<sup>®</sup> Exchanger (with no Drain)

6. Disconnect the plumbing to the heat pump at connection unions (removal is counter-clockwise).
7. Allow water to drain completely from the heat pump. Expect to see a lot of water drain out at first, and then a small amount to continue to drain out over a long period.
8. After heat pump has fully drained, partially reconnect plumbing connection unions.
9. Winterizing is complete.
10. When ready to use the heat pump again, hand-tighten connection unions. Reconnect electrical power, and set the operating mode on the heat pump. Activate the filter pump.

No Drain



## Titanium Tube-in-Tube Exchanger

**Titanium  
Tube-in-  
Tube**

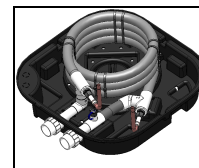

6. Disconnect the plumbing to the heat pump at connection unions (removal is counter-clockwise).
7. Allow water to drain completely from the heat pump. Expect to see a lot of water drain out at first, and then a small amount to continue to drain out over a long period.

8. Place an air hose into the water inlet of the heat pump; wrap a clean rag around the hose to form a temporary seal.
9. Push all water from the water circuit using compressed air no stronger than 50 psig (446 kPa). The residual water should be forced out of the heat pump's water outlet. Allow compressed air to blow into the heat pump inlet for at least 15-20 seconds after the water stops coming out.

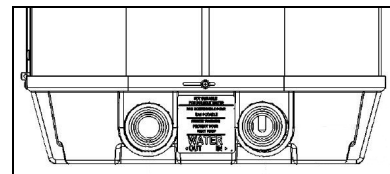

10. Repeat process on the outlet side of the heat pump.
11. Partially reconnect plumbing connection unions.
12. Winterizing is complete.
13. When ready to use the heat pump again, hand-tighten connection unions. Reconnect electrical power, and set the operating mode on the heat pump. Activate the filter pump.



**IN THIS SECTION:**

**Fault Codes**

AIR TEMP SENSOR OPEN or AIR TEMP SENSOR SHORT .....	35
CLOCK LOW BATTERY .....	35
DEFROST1 SENSOR OPEN or DEFROST2 SENSOR OPEN .....	36
DEFROST1 SENSOR SHORT or DEFROST2 SENSOR SHORT .....	36
ERROR AT PRIMARY UNIT .....	36
HIGH PRESSURE FAULT .....	37
HIGH WATER TEMPERATURE .....	37
HP5 SYSTEM LOCKOUT .....	38
HPC SYSTEM LOCKOUT .....	38
LOW PRESSURE FAULT .....	39
LP5 SYSTEM LOCKOUT .....	39
MULTI-UNIT COMM FAULT .....	40
OTA SYSTEM LOCKOUT .....	40
SMART COMM FAULT .....	40
VARIABLE DRIVE FAULT .....	40
WATER TEMP SENSOR SHORT or WATER TEMP SENSOR OPEN .....	40

**Issues and resolutions**

Blank Display .....	41
Display Panel Not Responding .....	41
Displays "DEFROSTING" .....	42
Displays "NO SYSTEM FIRMWARE" .....	42
Displays "NO POOL/SPA WATER FLOW" .....	42
Displays "SET TO SWITCH REMOTELY" .....	43
Displays "SET UNIT MODEL NUMBER" .....	43
Heat Pump Not Running .....	43
Heat Pump's Tripping Breaker .....	44
Heat Pump Won't Shut Off .....	44
Heat Pump Is Running, Not Heating .....	45
Heat Pump Is Running, Not Cooling .....	46
Ice Forming on the Heat Pump .....	47
"Pool / Spa" Button Will Not Work .....	47
Water Coming From Heat Pump .....	48

### 3.1 Fault Codes

A fault code indicates a specific issue or condition that will require action before the equipment can resume operating.

Please perform the following troubleshooting.

If the issue reoccurs, please contact AquaCal. See "*Contacting AquaCal AutoPilot, Inc.*" on page 1.

#### DANGER

Failure to heed the following will result in injury or death.

- RISK OF ELECTRICAL SHOCK FROM ENERGY STORED IN CAPACITORS - MODELS EQUIPPED WITH VARIABLE FREQUENCY COMPRESSOR DRIVES STORE ELECTRICITY EVEN AFTER THE POWER HAS BEEN DEACTIVATED AT THE POWER BREAKER. ***Wait for 2 minutes after the shut down of equipment before servicing.***
- Deactivate power while routing wiring to control board.
- Follow all National Electric Codes (NEC) and/or State and Local guidelines.

#### WARNING

Failure to heed the following may result in injury or death.

- Repairs must not be attempted by untrained or unqualified individuals.
- The heat pump contains refrigerant under high pressure. Repairs to the refrigerant circuit must not be attempted by untrained or unqualified individuals. Service must be performed only by qualified HVAC technicians. Recover refrigerant before opening the system.

#### NOTICE

Failure to heed the following may result in damage to equipment.

- Service by unauthorized personnel will void the heat pump warranty.

### AIR TEMP SENSOR OPEN or AIR TEMP SENSOR SHORT

#### ISSUE

Open or shorted air sensor.

#### RESOLUTION

A qualified technician should replace the air sensor.

### CLOCK LOW BATTERY

#### ISSUE

The real-time clock controller indicates a low battery condition.

- The time will reset to factory default.
- If connected, a gas backup heater may start and stop at an incorrect time when set to use a "SCHEDULED" mode.

#### RESOLUTION

A qualified technician should replace the battery. The date and time will need to be reset on the heat pump after replacement.

### **DEFROST1 SENSOR OPEN or DEFROST2 SENSOR OPEN**

#### **ISSUE**

Open defrost sensor.

#### **RESOLUTION**

A qualified technician should replace the defrost sensor.

### **DEFROST1 SENSOR SHORT or DEFROST2 SENSOR SHORT**

#### **ISSUE**

Shorted defrost sensor.

#### **RESOLUTION**

A qualified technician should replace the defrost sensor.

### **ERROR AT PRIMARY UNIT**

#### **ISSUE**

The heat pump is secondary to a primary heat pump that is displaying a fault code.

#### **RESOLUTION**

The error at the primary heat pump must be corrected before the secondary unit will resume operation.

## HIGH PRESSURE FAULT

### ISSUE

The refrigerant system's high-pressure switch is showing as open.

### RESOLUTION

#### Heat Only Units

Place heat pump in heating mode and perform the following troubleshooting.

Determine if an insufficient amount of water is being supplied to the equipment.

1. Confirm the filter pump is on.
2. If a multiple-speed filter pump is being used, run filter pump at a higher speed. Do not exceed the maximum flow rate for the model.
3. Confirm water is not being diverted away from the heat pump.
  - See "*Water Flow Rates*" on page 26.
  - See "*Adjusting Water Flow Using  $\Delta T$  (Delta-T)*" on page 27.

#### Cool Only Units

Determine if an insufficient amount of air is being supplied to the equipment.

1. Check for proper fan operation. If the fan is not operating, contact AquaCal® Technical Support.
2. Check for obstructed airflow around the heat pump.
  - See "*Clearances*" on page 25.
3. Check for a dirty or blocked evaporator coil.
  - See "*Cleaning Equipment*" on page 24.

#### Heat and Cool Units (Reversing)

Place heat pump in heating mode and perform the following troubleshooting.

Determine if an insufficient amount of water is being supplied to the equipment.

1. Confirm the filter pump is on.
2. If a multiple-speed filter pump is being used, run filter pump at a higher speed. Do not exceed the maximum flow rate for the model.
3. Confirm water is not being diverted away from the heat pump.
  - See "*Water Flow Rates*" on page 26.
  - See "*Adjusting Water Flow Using  $\Delta T$  (Delta-T)*" on page 27.

## HIGH WATER TEMPERATURE

### ISSUE

Incoming water temperature has exceeded 110° F (43° C) and the unit has been deactivated. The heat pump will not operate until the incoming water temperature drops to 100° F (38° C) or lower.

### RESOLUTION

1. Determine if a gas heater is sending water directly to the heat pump. This situation would need to be corrected before continuing.
2. If a solar heater is sending water directly to the heat pump, the water can initially be hotter than 110° F (43° C). After the water from the solar panel normalizes, the fault will no longer display and the heat pump will resume as needed.
3. If the **HIGH WATER TEMPERATURE** fault continues to display, the water temperature sensor may require replacement.

## HP5 SYSTEM LOCKOUT

### ISSUE

The heat pump has locked due to five high-pressure faults during one call for heating or cooling.

### RESOLUTION

1. Deactivate then reactivate power to the heat pump to clear error.
2. Troubleshoot the high-pressure issue causing the error.
  - See "*HIGH PRESSURE FAULT*" on the previous page.

## HPC SYSTEM LOCKOUT

### ISSUE

The heat pump's controller board is overheating.

### RESOLUTION

A qualified technician should be contacted to correct the issue.

## LOW PRESSURE FAULT

### ISSUE

The refrigerant system's low-pressure switch is showing as open.

### RESOLUTION

#### Heat Only Units

Place heat pump in heating mode and perform the following troubleshooting.

1. Check for proper fan operation. If the fan is not operating, contact AquaCal® Technical Support.
2. Check for obstructed airflow around the heat pump.
  - See "*Clearances*" on page 25.
3. Check for a dirty or blocked evaporator coil.
  - See "*Cleaning Equipment*" on page 24.
4. Check for signs of heavy ice buildup on the coil.

#### Cool Only Units

Place heat pump in heating mode and perform the following troubleshooting.

Determine if an insufficient amount of water is being supplied to the equipment.

1. Confirm the filter pump is on.
2. If a multiple-speed filter pump is being used, run filter pump at a higher speed. Do not exceed the maximum flow rate for the model.
3. Confirm water is not being diverted away from the heat pump.
  - See "*Water Flow Rates*" on page 26.
  - See "*Adjusting Water Flow Using  $\Delta T$  (Delta-T)*" on page 27.

#### Heat and Cool Units (Reversing)

Place heat pump in heating mode and perform the following troubleshooting.

1. Check for proper fan operation. If the fan is not operating, contact AquaCal® Technical Support.
2. Check for obstructed airflow around the heat pump.
  - See "*Clearances*" on page 25.
3. Check for a dirty or blocked evaporator coil.
  - See "*Cleaning Equipment*" on page 24.
4. Check for signs of heavy ice buildup on the coil.

## LP5 SYSTEM LOCKOUT

### ISSUE

The heat pump has locked due to five low-pressure faults during one call for heating or cooling.

### RESOLUTION

1. Deactivate then reactivate power to the heat pump to clear error.
2. Troubleshoot the low-pressure issue causing the error.
  - See "*LOW PRESSURE FAULT*" above.

## MULTI-UNIT COMM FAULT

### ISSUE

Secondary heat pump is not receiving a signal from the primary heat pump.

### RESOLUTION

1. Confirm the primary heat pump is operating correctly. If, for example, no power is supplied to the primary heat pump, an error will appear on the secondary heat pumps.

## OTA SYSTEM LOCKOUT

### ISSUE

A malfunction has occurred that could allow the water temperature to surpass a safe level. An installed "Over Temperature Alarm" kit has disabled the system.

- See "*Over Temperature Alarm Kit*" on page 54 for more information.

### RESOLUTION

Call for service.

## SMART COMM FAULT

### ISSUE

Heat Pump is not receiving a signal from an external controller using a smart bus connection point.

### RESOLUTION

1. Confirm a smart bus external controller is being used.
  - If unsure, contact installer of heat pump for more information. The heat pump may need to be reconfigured to set external controller to "none".
2. If using a smart bus external controller, confirm the controller is correctly set to send signals to the heat pump. See manuals or guides provided with the external controller.

## VARIABLE DRIVE FAULT

### ISSUE

A problem was detected in the variable speed compressor.

### RESOLUTION

Deactivate heat pump at power disconnect. Wait for two minutes for the capacitors to discharge.

Then reactivate heat pump's power at disconnect. If error reoccurs, call for service.

## WATER TEMP SENSOR SHORT or WATER TEMP SENSOR OPEN

### ISSUE

Shorted or open water sensor.

### RESOLUTION

A qualified technician should replace the water sensor.



## 3.2 Issues and Resolutions

### DANGER

Failure to heed the following will result in injury or death.

- RISK OF ELECTRICAL SHOCK FROM ENERGY STORED IN CAPACITORS - MODELS EQUIPPED WITH VARIABLE FREQUENCY COMPRESSOR DRIVES STORE ELECTRICITY EVEN AFTER THE POWER HAS BEEN DEACTIVATED AT THE POWER BREAKER. ***Wait for 2 minutes after the shut down of equipment before servicing.***
- Deactivate power while routing wiring to control board.
- Follow all National Electric Codes (NEC) and/or State and Local guidelines.

### WARNING

Failure to heed the following may result in injury or death.

- Repairs must not be attempted by untrained or unqualified individuals.
- The heat pump contains refrigerant under pressure. Repairs to the refrigerant circuit must not be attempted by untrained or unqualified individuals. Service must be performed only by qualified HVAC technicians. Recover refrigerant before opening the system.

### NOTICE

Failure to heed the following may result in damage to equipment.

- Service by unauthorized personnel will void the factory warranty.

Please perform the following troubleshooting.

For further assistance, please contact AquaCal. See "*Contacting AquaCal AutoPilot, Inc.*" on page 1.

### Blank Display

#### ISSUE

The Heat Pump may have an incoming power problem.

#### RESOLUTION

Confirm electrical power is being supplied to the heat pump from electrical disconnect(s).

### Display Panel Not Responding

#### ISSUE

The heat pump's display panel will not respond to user input.

#### RESOLUTION

1. If heat pump display shows "**UNDER REMOTE CONTROL**", use the external control device to control the heat pump.
2. If needed, check with the external controller manufacturer for further assistance using that device.

## Displays "DEFROSTING"

### ISSUE

The heat pump has sensed the coil is icing up. See "*Ice Forming on the Heat Pump*" on page 47. No action is required.

### RESOLUTION

#### Heat Only Units - Passive Defrost

When ice starts to form on the coil, the compressor will stop operating while the fan continues to operate.

- The coil will begin to warm to the surrounding air temperature. When the coil's temperature rises above 38° F (3.3° C), the compressor is restarted and heating resumes.
- If the coil's temperature remains below 38° F (3.3° C), the compressor will remain off.

#### Cool Only Units - Passive Defrost

When ice starts to form on the coil, the compressor will stop operating while the fan continues to operate.

- The coil will begin to warm to the surrounding air temperature. When the coil's temperature rises above 38° F (3.3° C), the compressor is restarted and cooling resumes.
- If the coil's temperature remains below 38° F (3.3° C), the compressor will remain off.

#### Heat and Cool Units - Active Defrost

Hot refrigerant gas will be sent through the coil to rapidly remove ice or frost.

During this process, the melting of the ice may appear as steam coming off the heat pump. This is normal.

## Displays "NO SYSTEM FIRMWARE"

### ISSUE

The heat pump has encountered a software error.

### RESOLUTION

Call for service.

## Displays "NO POOL/SPA WATER FLOW"

### ISSUE

Low or no water detected. This is normal when the circulation pump is deactivated.

### RESOLUTION

1. Confirm the filter pump is on.
2. If a multiple-speed filter pump is being used, run at a higher speed to determine if the error persists. Do not exceed the maximum flow rate for your model.
3. Confirm water is not being diverted away from the heat pump.
  - See "*Water Flow Rates*" on page 26.
  - See "*Adjusting Water Flow Using  $\Delta T$  (Delta-T)*" on page 27.

## Displays "SET TO SWITCH REMOTELY"

### ISSUE

If when pressing the "Pool / Spa" button the display flashes the message "**SET TO SWITCH REMOTELY**", the heat pump is using a remote relay switch or a 3-wire controller.

### RESOLUTION

- The Pool and Spa thermostat automatically switch when using these modes.
- Operation manually will not be available when using these external devices. No action is required.

## Displays "SET UNIT MODEL NUMBER"

### ISSUE

The heat pump has encountered a software error.

### RESOLUTION

- The model number and serial number will need to be re-entered into the system. The system will then operate as normal.
- If the issue reoccurs, please contact the distributor or installing dealer.

## Heat Pump Not Running

### ISSUE

The heat pump will not run.

### RESOLUTION

1. Confirm equipment is receiving power. Is the heat pump display illuminated?
  - If not, confirm the main breaker (located at the power supply panel) and the disconnect switch (located near the heat pump) are both turned on.
  - If the display still does not illuminate, it is recommended that the heat pump installer or electrician confirm the heat pump is receiving power.
2. Confirm correct mode is selected.
  - See "*Activate Heat Mode, Cool Mode, Auto Mode, or Deactivate Equipment*" on page 6.
3. Confirm thermostat is set correctly.
  - When heating the water is desired, the thermostat should be set above the current water temperature.
  - When cooling the water is desired, the thermostat should be set below the current water temperature.
  - See "*Set Temperature*" on page 7.
4. If an error code is displayed, diagnose and correct the cause of the code.
  - See "*Fault Codes*" on page 35.
5. If the heat pump is using an external controller, the heat pump may not be set correctly to accept the controller's signal.
  - See "*Operating Heat Pump (With an External Controller)*" on page 20

## Heat Pump's Tripping Breaker

### ISSUE

The heat pump breaker(s) keeps tripping.

### RESOLUTION

1. If AquaCal® heat pumps have been connected using a multiple heat pump configuration, the configuration may be incorrect. Please confirm settings or contact installer of equipment.
2. Have an electrician confirm breakers are correct type, in good condition, and properly sized for the heat pump.

## Heat Pump Won't Shut Off

### ISSUE

The heat pump will not deactivate.

### RESOLUTION

#### **PLEASE NOTE**

*When the heat pump is set to off, the display will show the current water temperature or no water flow indicator.*

1. Confirm the correct mode has been set on the heat pump.
  - See "Activate Heat Mode, Cool Mode, Auto Mode, or Deactivate Equipment" on page 6.
2. Confirm the heat pump has reached the desired temperature set on the thermostat. The heat pump will continue to run until the set temperature is reached.
  - See "Set Temperature" on page 7.
3. If the heat pump is using an external controller, it may not be set correctly. See the external controller's manual.

### ISSUE

The heat pump is running. But the water is not heating.

### RESOLUTION

1. If the heat pump is using an external controller, confirm it is set correctly.
  - See "*Operating Heat Pump (With an External Controller)*" on page 20.
  - If the heat pump is still not running correctly with this device, contact the installer of the device or the device's manufacturer for further assistance.
2. Confirm heat pump mode is set to heat.
3. Confirm thermostat is set to the desired water temperature.
4. Confirm valves are positioned to heat the correct body of water (either the pool or the spa). If heating a spa that overflows into a pool, confirm the spa is isolated when being heated (not flowing into the pool).
5. Confirm heat pump is transferring heat into the water.
  - Measure the temperature of air discharge coming out of the heat pump fan. If discharge air is between 8° to 10° F (4.4° to 5.6° C) colder than the outside ambient air, the heat pump is moving heat into the water.
6. If an error code is displayed, diagnose and correct cause of code.
  - See "*Fault Codes*" on page 35.
7. Confirm that the filter pump has a sufficient run-time. The heat pump will not run (or heat the water) without water flow.
  - See "*Heating Recommendations*" on page 53.
8. If heating a spa, deactivate air blower or venturi (if equipped) to allow for quicker heating times. For pools, deactivate water features, such as slides, waterfalls, or fountains to allow water to retain heat. Use of a liquid pool blanket product, such as an Aqua Blanket™, can also compensate for excessive heat loss.
  - See "*Liquid Blankets*" on page 54.

### ISSUE

The heat pump is running. But the water is not cooling.

### RESOLUTION

1. If the heat pump is using an external controller, confirm the heat pump is programmed properly to allow for cooling.
  - See "*Operating Heat Pump (With an External Controller)*" on page 20.
2. Confirm the heat pump mode is set to cool.
3. Confirm the thermostat is set below the current water temperature.
4. Confirm valves are positioned to cool the correct body of water (either the pool or the spa). If cooling a spa that overflows into a pool, confirm the spa is isolated when being cooled (not flowing into the pool).
5. If an error code is displayed, determine and correct the condition causing the code.
  - See "*Fault Codes*" on page 35.
6. Confirm heat pump is transferring heat out of the water.
  - Measure the temperature of air discharge coming out of the heat pump's fan. If the air is between 8° to 10° F (4.4° to 5.6° C) warmer than the outside ambient air, the heat pump is moving heat out of the water.
7. Confirm that the filter pump has a sufficient run-time. The heat pump will not run (or cool the water) without water flow.
  - See "*Cooling Recommendations*" on page 53.

## Ice Forming on the Heat Pump

### ISSUE

When conditions are too cold for proper operation, the heat pump will enter a defrost mode. This prevents ice from building up on the evaporator coil.

### RESOLUTION

#### Heat Only Units:

- The heat pump may develop a fine layer of white frost on the outside coil before entering the defrost mode. This is normal.
  - See "*Displays Defrosting*" on page 42.
- If heavy ice (not frost) starts to build up, shut off the heat pump. Contact the installer or manufacturer.
- If the ambient air temperature will be falling below 32° F (0° C) for more than 8 hours, winterize equipment.
  - See "*Winterizing*" on page 31.

#### Cool Only Units

- The heat pump may enter defrost mode if the water flow rate falls below the acceptable range. See "*Water Flow Rates*" on page 26.
- If the ambient air temperature will be falling below 32° F (0° C) for more than 8 hours, winterize equipment.
  - See "*Winterizing*" on page 31.

#### Heat and Cool Units (with Active Defrost or "Icebreaker"):

- During freezing conditions, pool or spa heating will continue. Frost or ice may develop during the "countdown" to the active defrost (up to 50 minutes). This is normal. See "*Displays Defrosting*" on page 42.
- The heat pump will enter an "active defrost" stage to remove the accumulated frost and ice.
  - Be sure to observe the unit for at least 50 minutes. If it has not entered an active defrost cycle, call for service.

#### **TIP:**

*The heat pump can be manually set to defrost by temporarily switching to the cooling mode until the ice or frost melts.*

- If the ambient air temperature is (or will be) falling below 32° F (0° C) for more than 8 hours, winterize equipment.
  - See "*Winterizing*" on page 31.

## "Pool / Spa" Button Will Not Work

### ISSUE

The "Pool / Spa" button is disabled if the following devices have been configured on the heat pump. Check with installer if unsure of devices enabled on heat pump.

### RESOLUTION

- A 2-wire external controller.
- A 3-wire external controller.
- An external flow switch.



### ISSUE

The water may be normal condensation produced as a by-product of the heat pump's refrigeration process.

The heat pump can produce up to 8 to 10 gallons (30 to 38 liters) of condensation per hour depending on the humidity of the ambient air. Determine if the water is condensation or a possible leak.

### RESOLUTION

1. Deactivate heat pump, leaving the filter pump on. After several hours, determine if the water is still coming from the heat pump.
2. If using chlorine or bromine as a pool/spa sanitizer, test the water around the heat pump using a test strip. If the test strip indicates that chlorine or bromine is present, a leak may exist.

#### **PLEASE NOTE -**

*If desired, a kit is available to re-direct condensation water away from the heat pump.*

- See "Condensation Drain Kit (# STK0202)" on page 53.

**IN THIS SECTION:**

4.1 Factory Defaults .....	49
4.2 Identifying Model Specifications .....	50
4.3 Weights .....	52
4.4 Heating Recommendations .....	53
4.5 Cooling Recommendations .....	53
4.6 Available Accessories .....	53

**4.1 Factory Defaults**

Certain programming options have been preset at the factory. These options can be overwritten for site-specific conditions.

**NOTICE**

Failure to heed the following may result in damage to equipment.

- Unauthorized adjustments in Service Menu (**not shown**) may void the heat pump's warranty.

User Menus		
MENUS	DEFAULT	OPTIONS
<b>SET GAS BOOST</b>	OFF	OFF ON
<b>SET TIME / DATE</b>	USER TO SET	
<b>SET BACKUP HEAT MODE</b>	OFF	OFF SCHEDULED 24HR
<b>SET ENTRY CODE ENABLED</b>	OFF	OFF ON
<b>SET USER ENTRY CODE</b>	01	
<b>SET CALL-FLEX MODE</b>	OFF	OFF CALL FLEX

**PLEASE NOTE:**

*Changing settings programmed by the heat pump installer in advanced menus is **not** advised. A loss of heat pump functionality may occur.*

Installer Menus		
MENUS	DEFAULT	OPTIONS
SET MULTI-UNIT MODE	OFF	OFF PRIMARY SECONDARY
SET EXT. CTRL MODE	OFF	OFF SMART 2WIRE 3WIRE
SET TIME FORMAT	12 Hour	12 Hour 24 Hour
SET DATE FORMAT	MDY	MDY DMY
SET TEMPERATURE UNITS	Fahrenheit	Fahrenheit Celsius
SET BACKUP HEAT MODE	OFF	OFF SCHEDULED 24HR
SET ENTRY CODE ENABLED	OFF	OFF ON
SET USER ENTRY CODE	01	
SET CALL-FLEX INSTALLED	NO	YES NO
SET CALL-FLEX MODE	OFF	OFF CALL FLEX

**4.2 Identifying Model Specifications**

1. Find Data Plate - The data plate is usually posted on the side of the equipment or the inside of the heat pump's access plate.
2. Find the model number on the data plate. The first letters and numbers indicate the model type.
3. The complete model number identifies the equipment's specifications.

**Data Plate Example**

MINIMUM CIRCUIT AMPACITY  MADE IN THE USA  
 ELEC. SERVICE: VOLTS  PH  HZ   
 MAXIMUM TIME DELAY FUSE OR HACR BREAKER  5  
 COMPRESSOR VOLTS  R.L.A.  L.R.A.   
 FAN MOTOR VOLTS  H.P.  F.L.A.   
 REFRIGERANT: Circuit - Factory charged  Only oz/Kg   
 Tested to  psig High side /  psig Low side

OUTDOOR UNIT

AQUA CAL, INC  
 A TEAM HORNER COMPANY  
 2737 24<sup>TH</sup> STREET NORTH  
 ST. PETERSBURG, FL 33713  
 FACTORY SERVICE  
 727-823-5542

MODEL NUMBER   
**|||BAR CODE|||**  
 SERIAL NUMBER   
**|||BAR CODE|||**

## Model Number Example

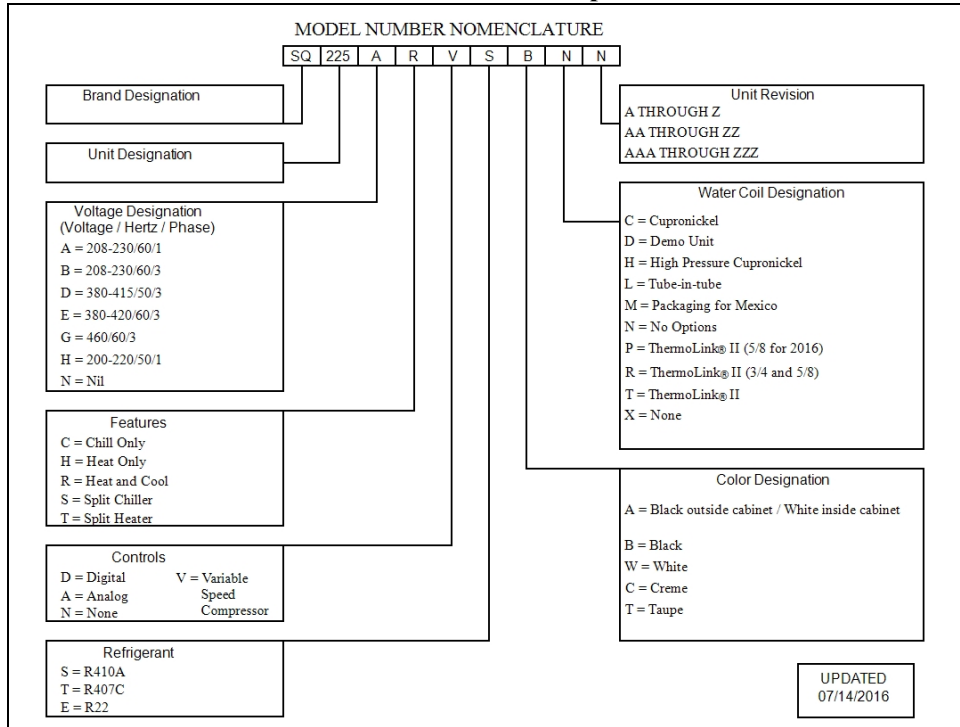

### 4.3 Weights

**NOTE:**

*Specifications subject to change.*

Model Type	Model Number	Install Weight
TropiCal®	T030	120 Pounds (54 kg)
TropiCal®	T035	180 Pounds (81.6 kg)
TropiCal®	T055	180 Pounds (81.6 kg)
TropiCal®	T075	200 Pounds (90.7 kg)
TropiCal®	T090	255 Pounds (115.7 kg)
TropiCal®	T115	259 Pounds (117.5 kg)
TropiCal®	T135	287 Pounds (130 kg)
TropiCal®	T170	326 Pounds (148 kg)
HeatWave SuperQuiet®	SQ120R	268 Pounds (121.6 kg)
HeatWave SuperQuiet®	SQ125	268 Pounds (121.6 kg)
HeatWave SuperQuiet®	SQ145	328 Pounds (148.8 kg)
HeatWave SuperQuiet®	SQ150VS	350 Pounds (158.8 kg)
HeatWave SuperQuiet®	SQ166R	328 Pounds (148.8 kg)
HeatWave SuperQuiet®	SQ225	328 Pounds (148.8 kg)
TropiCool®	TC500	215 Pounds (97.5 kg)
TropiCool®	TC1000	285 Pounds (128.8 kg)
TropiCool®	TC1500	328 Pounds (148.8 kg)

#### 4.4 Heating Recommendations

The following recommendations will reduce the amount of time required to heat a pool. **If unsure of equipment heating capability, review equipment data plate.** See "*Identifying Model Specifications*" on page 50.

1. Confirm heat pump mode has been set to heating mode.
2. Set the desired temperature (set-point) for the water.
3. Temporarily set the filter pump for continuous operation.
  - This will allow the Heat Pump the time required to heat the water at start-up.
  - After the water has reached the desired temperature, reset the filter pump to normal operating time-frames.
4. Activate Turbo Boost Mode if equipped.
5. Use a pool cover or blanket to reduce heating time.

#### 4.5 Cooling Recommendations

The following recommendations will reduce the amount of time required to cool a pool or cold plunge application. **If unsure of equipment cooling capability, review equipment data plate.** See "*Identifying Model Specifications*" on page 50.

1. Confirm heat pump mode has been set to cooling mode.
2. Set thermostat to desired water temperature.
3. Activate Turbo Boost Mode if equipped.
4. Temporarily set the filter pump for continuous operation.
  - This will allow the Heat Pump the time required to cool the water at start-up.
  - After the water has reached the desired temperature, reset the filter pump to normal operating time-frames.

#### 4.6 Available Accessories

Accessories may be purchased through an authorized dealer of AquaCal® products.

##### Bypass Valve Kit (# STK0135)

- When high flow rates are outside recommended specifications, please use this kit or an alternative bypass valve system.
- This kit can be used to control excessive water flow through the heat pump. It provides automatic flow adjustments for most applications.



##### Condensation Drain Kit (# STK0202)

- Used when condensation water flow must be directed to a specific location.



### Call Flex Accessory (# 0030-LEDS)

- This accessory will override a circulation pump to provide water to the heat pump when the set temperature is not met.

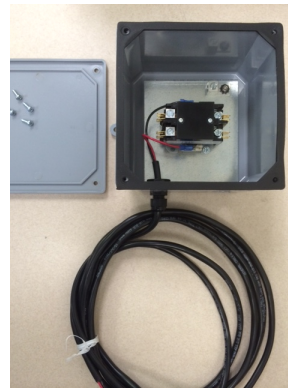

### Grid Flow Switch (# 0040S)

- Used for automatic pool/spa thermostat switching.
- This kit is not to be used on applications exceeding 50 PSI (345 kPa).



### Liquid Blankets

- An invisible liquid heat barrier designed to retain heat and extend the swimming season.
- AquaCal® recommends [Lo-Chlor®](#) Aqua Blanket™.



### Over Temperature Alarm Kit

- This kit is an additional safety device. It disables the heat pump if any malfunction occurs that allows the water temperature to surpass a safe level.
- This kit is strongly recommended for all spa applications.
  - Single Phase Heat Pump - (# STK0221)
  - Three Phase Heat Pump - (# STK0222)

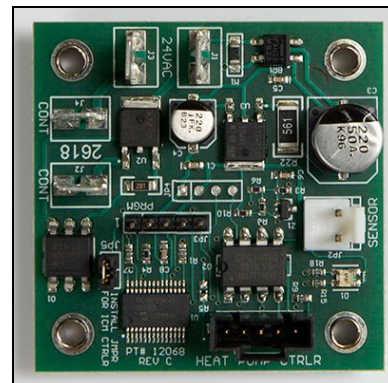



## Plumbing Unions

- 2 Inch Unions - (# PLS2627)



## Temperature Port Kit (# STK0096)

- This kit can be used to adjust water flow using Delta-T.
- The kit comes with a port, installation components, and a temperature probe.



